

# ORTHOPEDIC

INSTRUMENTS CATALOGUE

[www.mediworldsurgical.com](http://www.mediworldsurgical.com)

For 13-100-35



Spare saw blade  
 13-100-12 12mm  
 13-100-15 15mm  
 13-100-18 18mm

blade width



Charriere  
 13-100-35  
 35 cm



Langenbeck  
 13-110-23  
 23 cm



Charriere  
 13-112-27  
 27 cm



Satterlee  
 13-114-31  
 31 cm

Bone Surgery - Knochenchirurgie - Cirugía ósea  
 Bone Drills, Reamers  
 Bohrinstrumente, Pfrieme  
 Instrumental para perforar, Escariadores



1/2  
 13-120-14  
 14 cm



Perthes  
 13-122-18  
 18 cm



Perthes  
 13-124-21  
 21 cm



1/3  
 13-126-14  
 14 cm

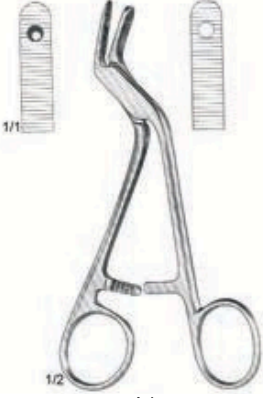

1/2  
 Adson  
 13-129-15  
 15 cm





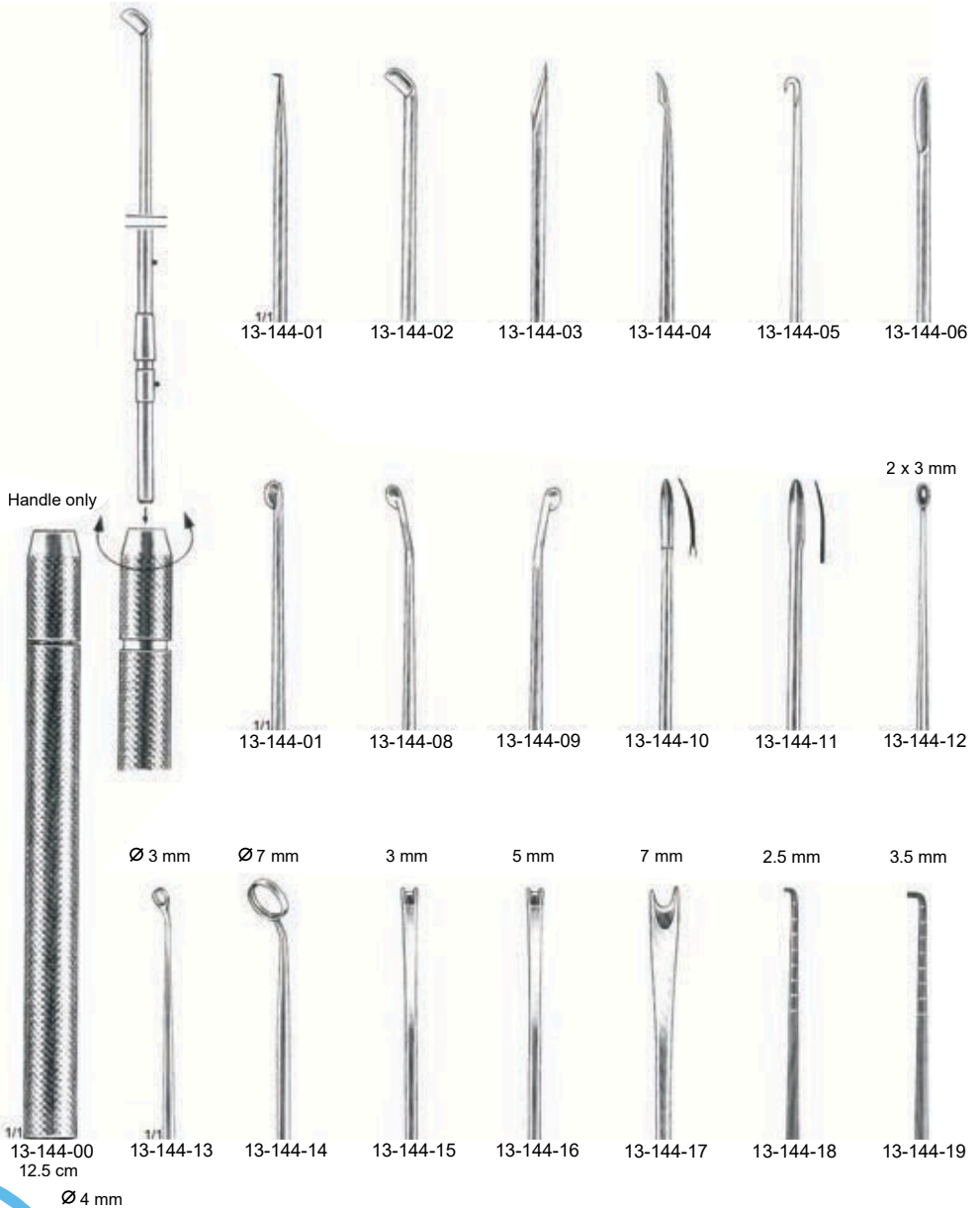

1/1  
13-140-01  
22.5 cm

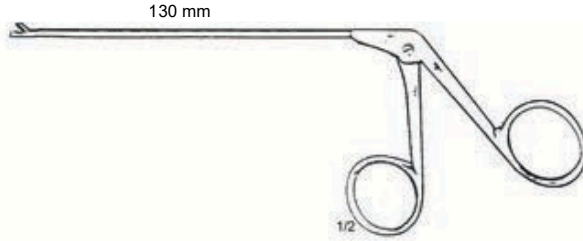







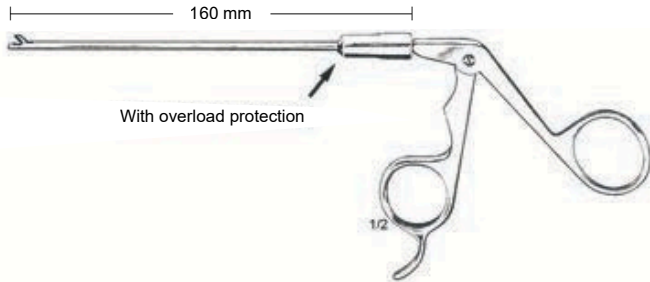





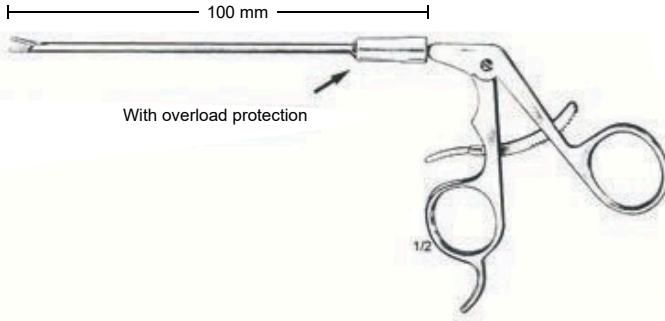

		straight	7° curved up	15° curved up	30° curved right	30° curved left
	Ø 2.7 mm Ø 3.4 mm Ø 4.5 mm	13-150-10 13-151-10 13-152-10	13-150-11 13-151-11 13-152-11	13-150-13 13-151-13 13-152-13	13-150-15 13-151-15 13-152-15	13-150-17 13-151-17 13-152-17
	Ø 2.7 mm Ø 3.4 mm Ø 4.5 mm	13-153-10 13-154-10 13-155-10	13-153-11 13-154-11 13-155-11	13-153-13 13-154-13 13-155-13	13-153-15 13-154-15 13-155-15	13-153-17 13-154-17 13-155-17
	Ø 3.4 mm	13-156-10	13-156-11	13-156-13	13-156-15	13-156-17
	Ø 3.4 mm	13-157-10	13-157-11	13-157-13	13-157-15	13-157-17



		straight	7° curved up	15° curved up	30° curved right	30° curved left
	Ø 2.7 mm Ø 3.4 mm Ø 4.5 mm	13-158-10 159-10 13-160-10	13-158-11 159-11 13-160-11	13-158-13 13-159-13 160-13	13-158-15 13-159-15 160-15	13-158-17 13-159-17 160-17
	Ø 2.7 mm Ø 3.4 mm Ø 4.5 mm	13-161-10 162-10 13-163-10	13-161-11 162-11 13-163-11	13-161-13 13-162-13 163-13	13-161-15 13-162-15 163-15	13-161-17 13-162-17 163-17
	Ø 3.4 mm	13-164-10	13-164-11	13-164-13	13-164-15	13-164-17
	Ø 3.4 mm	13-165-10	13-165-11	13-157-13	13-165-15	13-165-17



					
	straight	7° curved up	15° curved up	30° curved right	30° curved left
Ø 3.4 mm	13-170-10	13-170-11	13-170-13	13-170-15	13-170-17

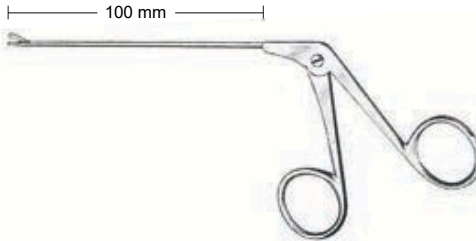

	
Ø 2 mm	13-175-10



	
Ø 2 mm	13-175-20



	
Ø 2 mm	13-175-30



	
Ø 2 mm	13-175-40

Bone Surgery -Knochenchirurgie - Cirugía ósea  
Bone Holding Clamps  
Knochenhalteklammerm  
Pinzas porta - huesos

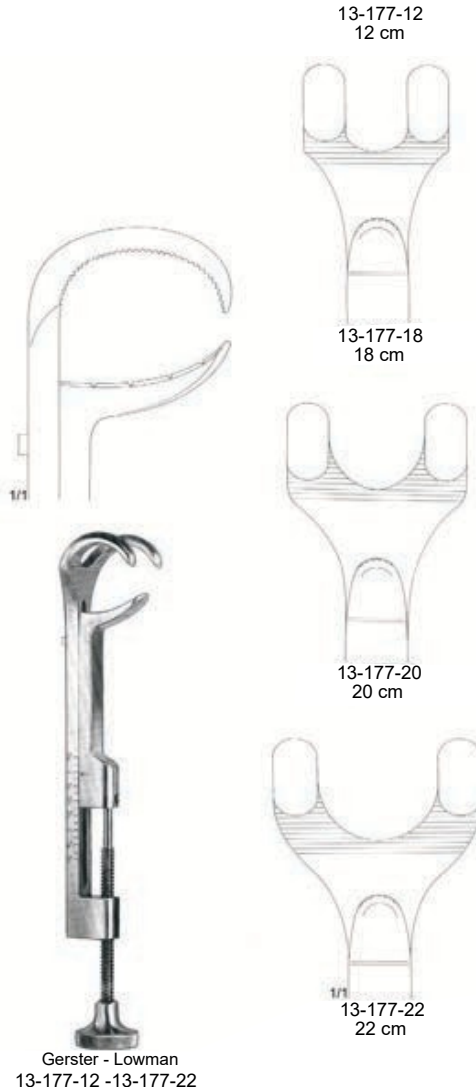

Bone Surgery - Knochenchirurgie - Cirugía ósea  
 Bone Holding Clamps  
 Knochenhalteklammern  
 Pinzas porta - huesos



Gerster  
 13-178-09  
 9 cm



Lowman - Baby  
 13-178-18  
 18 cm



Lowman - Hoglund  
 13-178- 18  
 18 13- cm  
 178-20 20  
 13-178- cm  
 22 22  
 cm



Bunnell - Howard  
 13-179-15  
 15 cm



Lambert - Lowman  
 13-179- 18  
 18 13- cm  
 179-20 20  
 13-179- cm  
 22 22  
 cm

Extension



1/3  
 13-180-09



Brace

1/3  
 Hudson  
 13-180-27  
 27 cm



13-180-01  
 Ø 9 mm

13-180-02  
 Ø 14 mm

13-180-03  
 Ø 16 mm

13-180-04  
 Ø 22 mm

Burrs

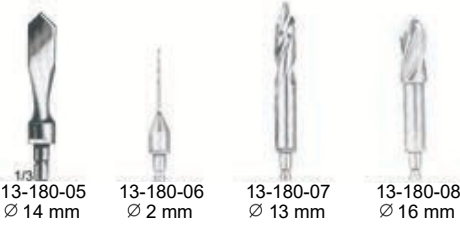

1/3  
 13-180-05  
 Ø 14 mm

13-180-06  
 Ø 2 mm

13-180-07  
 Ø 13 mm

13-180-08  
 Ø 16 mm

Burrs

13-181-00 (Complete Set)  
 13-181-01 (Brace,Extension With 4 Burrs)



Ralk  
13-182-00



Bunnell  
13-182-10



Stille - Sherman  
 13-184-24  
 24 cm

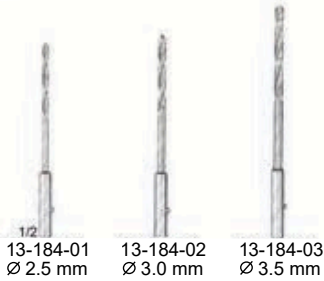

13-184-01 Ø 2.5 mm  
 13-184-02 Ø 3.0 mm  
 13-184-03 Ø 3.5 mm

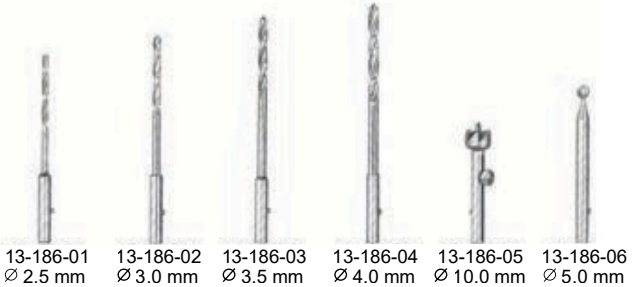

13-186-01 Ø 2.5 mm  
 13-186-02 Ø 3.0 mm  
 13-186-03 Ø 3.5 mm  
 13-186-04 Ø 4.0 mm  
 13-186-05 Ø 10.0 mm  
 13-186-06 Ø 5.0 mm



Stille  
 13-186-20  
 20 cm

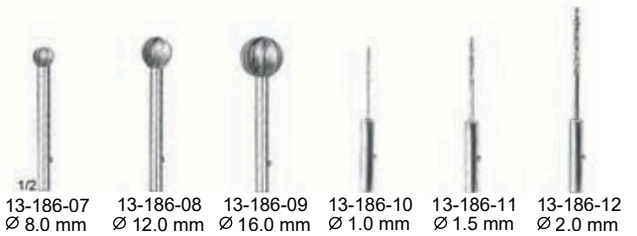

13-186-07 Ø 8.0 mm  
 13-186-08 Ø 12.0 mm  
 13-186-09 Ø 16.0 mm  
 13-186-10 Ø 1.0 mm  
 13-186-11 Ø 1.5 mm  
 13-186-12 Ø 2.0 mm

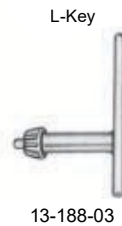
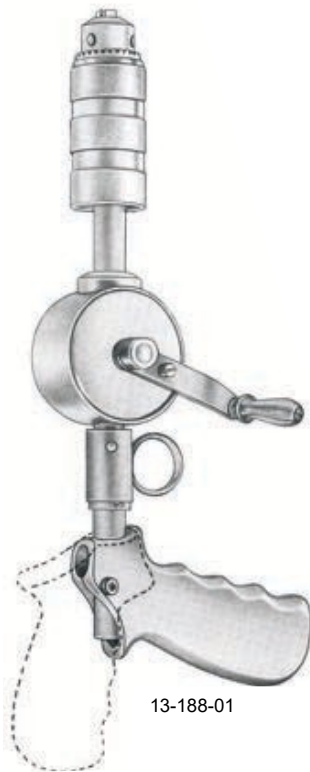



13-190-01  
15 cm

13-190-01 - 13-190-02



13-190-02  
18 cm



13-190-11  
15 cm

13-190-11 - 13-190-12



13-190-12  
18 cm



13-190-15  
15 cm



13-190-20  
20 cm

Bone Surgery -Knochenchirurgie - Cirurgia ósea  
 Wire Twisting Forcep  
 Draht - Zangen  
 Pinzas para trocer hilos



Martin  
 13-191-14  
 14.5 cm



Corwin - Hegar  
 13-192-16  
 16 cm



Martin - TC  
 13-194-18  
 18 cm



13-196-18  
 18.5 cm

Bone Surgery - Knochenchirurgie - Cirurgia ósea  
Wire Twisting Forcep  
Draht - Zangen  
Pinzas para trocer hilos



13-198-15  
15 cm



13-200-17  
17 cm



Baumgartner  
13-202-20  
20 cm

Bone Surgery - Knochenchirurgie - Cirugía ósea  
 FlatNose Pliers, Wire Cutting Pliers  
 Elachzangen, Draht - Kneifzangen  
 Alicates planos, Alicates para cortar alambre



13-203-17  
17 cm



13-204-18  
18 cm

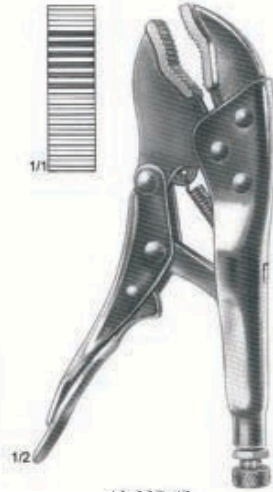

13-205-18  
18 cm

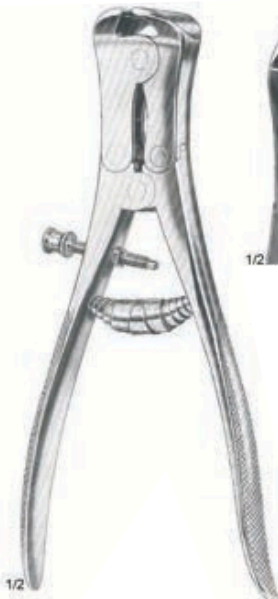

13-206-23  
23 cm



13-206-25  
25 cm

for bending and cutting



Universal  
13-208-15  
15 cm

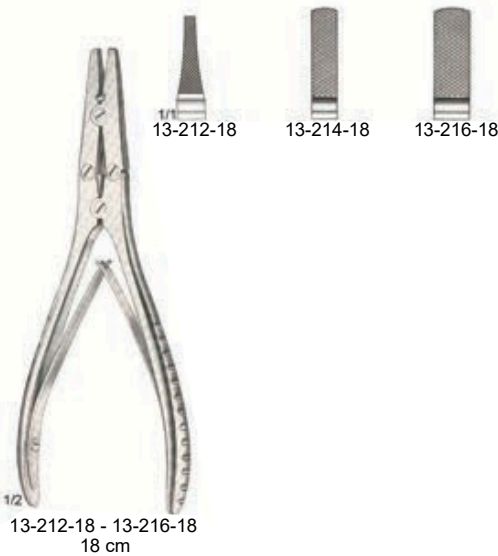
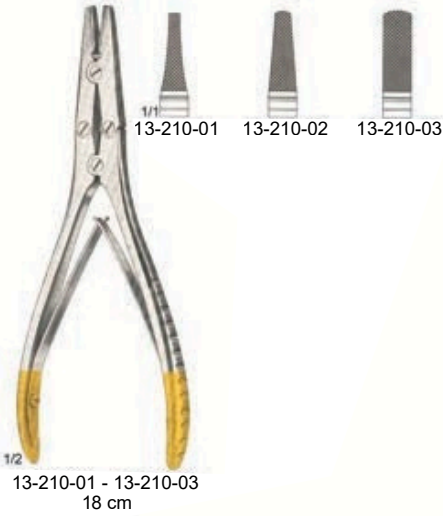

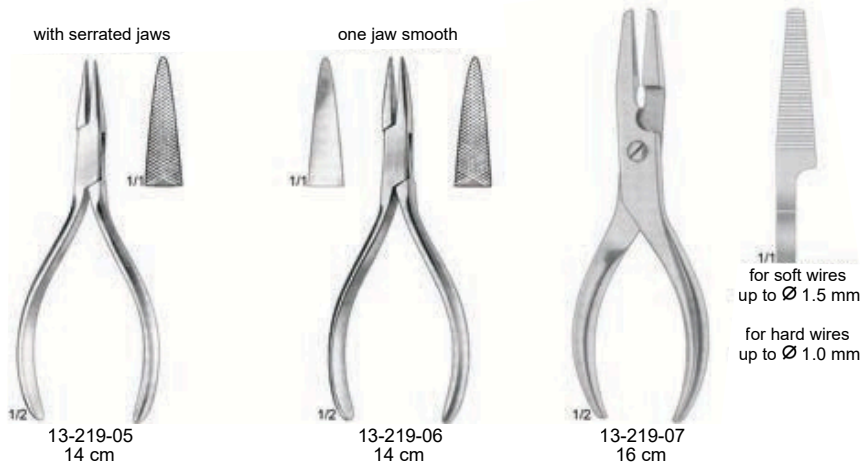
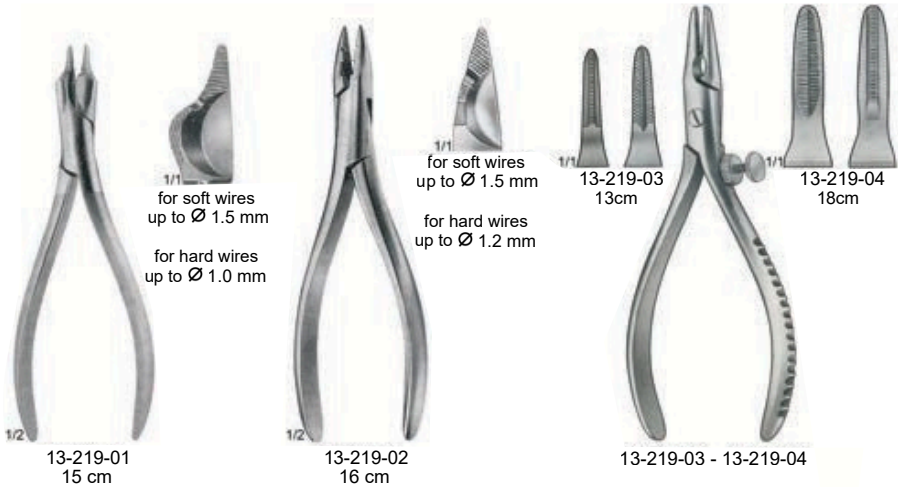

with longitudinal groove



Hackstock  
 13-220-16  
 16 cm

with crosswise groove



13-221-01 - 13-221-02  
 17 cm

pointed



13-221-03  
 19 cm

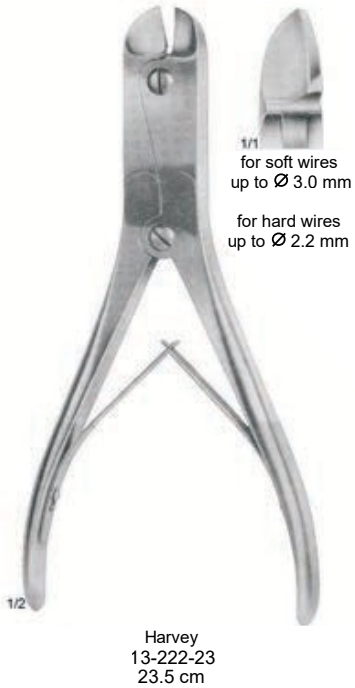

Bone Surgery - Knochenchirurgie - Cirurgia ósea  
 Wire Cutting Pliers  
 Draht - Kneifzangen  
 Alicates para cortar alambre

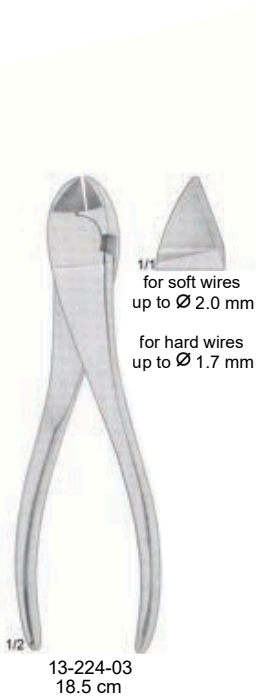
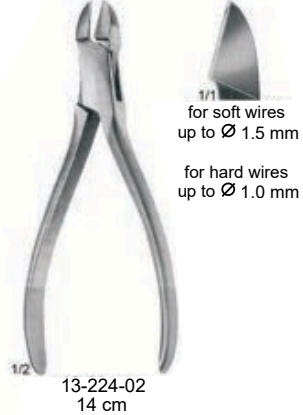
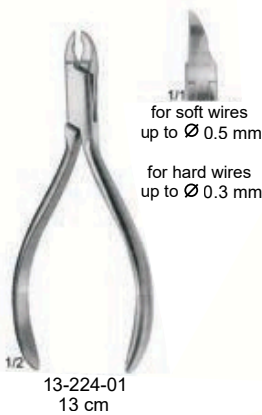

Bone Surgery - Knochenchirurgie - Cirurgia ósea  
 Wire Cutting Pliers  
 Draht - Kneifzangen  
 Alicates para cortar alambre



for soft wires  
 up to  $\varnothing$  2.4 mm  
 for hard wires  
 up to  $\varnothing$  1.8 mm

1/2

13-230-16  
 16 cm



for soft wires  
 up to  $\varnothing$  2.2 mm  
 for hard wires  
 up to  $\varnothing$  2.0 mm

1/2

Martin - Diamant  
 13-232-16  
 16 cm

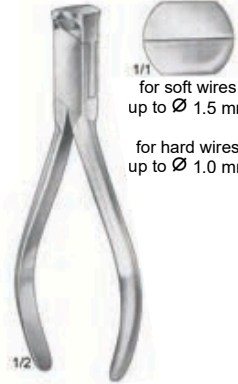

for soft wires  
 up to  $\varnothing$  1.5 mm  
 for hard wires  
 up to  $\varnothing$  1.0 mm

1/2

13-233-14  
 14.5 cm



for soft wires  
 up to  $\varnothing$  2.0 mm  
 for hard wires  
 up to  $\varnothing$  1.2 mm

1/2

13-234-15  
 15 cm

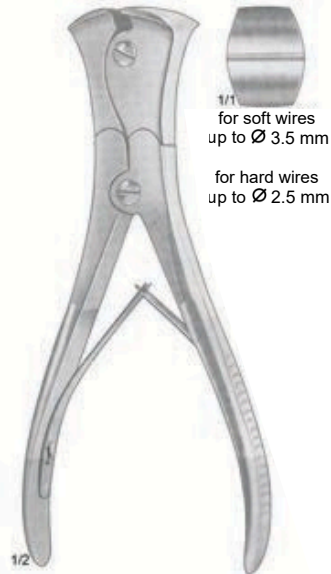

for soft wires  
 up to  $\varnothing$  3.5 mm  
 for hard wires  
 up to  $\varnothing$  2.5 mm

1/2

13-234-22  
 22 cm

Bone Surgery - Knochenchirurgie - Cirurgia ósea  
 Wire Cutting Pliers  
 Draht - Kneifzangen  
 Alicates para cortar alambre

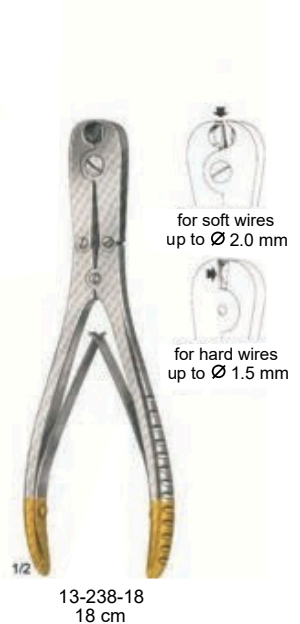
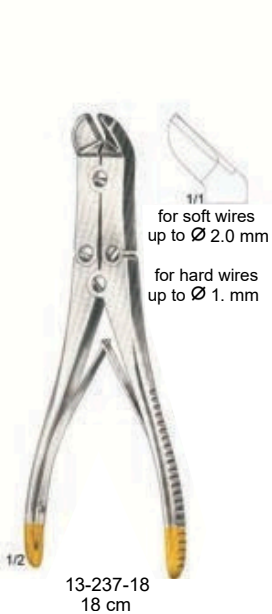
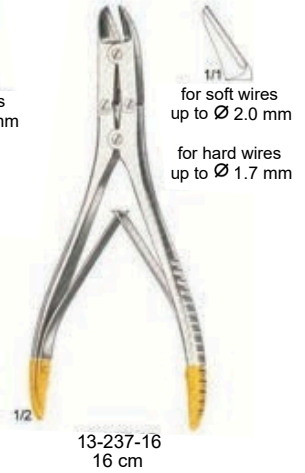
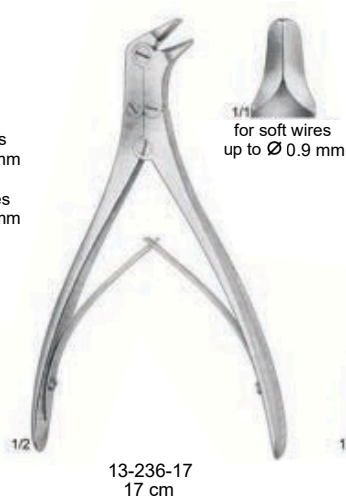
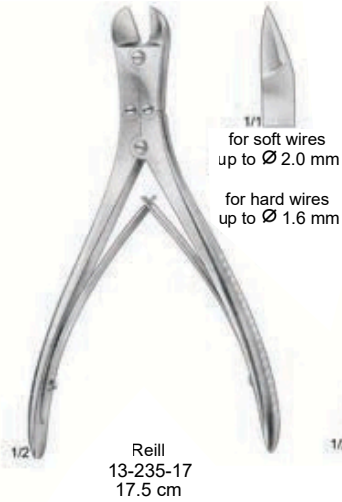



Demel  
13-240-01 - 13-240-03

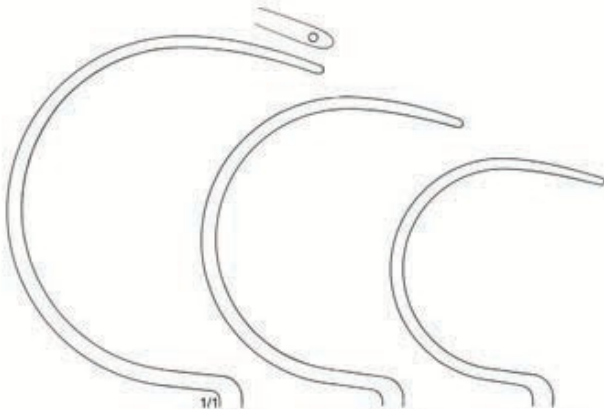

Fig. 1  
13-240-01  
31 cm

Fig. 2  
13-240-02  
29 cm

Fig. 3  
13-240-03  
28 cm



Loute  
13-242-21  
21 cm

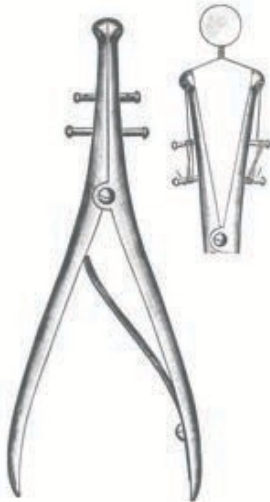

Demel  
13-244-28  
28 cm



Parham  
13-246-23  
23 cm



Parham  
13-246-22  
22 cm



Ø 45 mm

Ø 70 mm

13-248-45

13-248-70

Bone Surgery - Knochenchirurgie - Cirugía ósea  
 Extension Bows, Steinmann Pin..s, Clips  
 Extensionsbugel, Steinmann Nagel, Klammern  
 Extribos para extension, Grapas

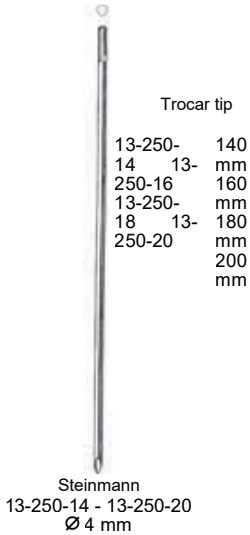

cm	h x b	
16 x 9	13-255-16	for arm
21 x 11	13-255-21	for thigh and knee
21 x 15	13-255-15	for femur and knee

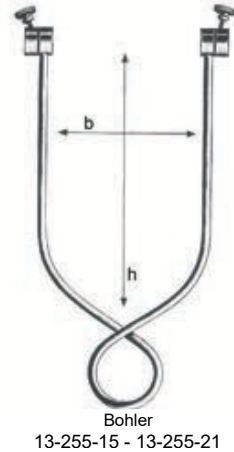

with 3 traction hooks

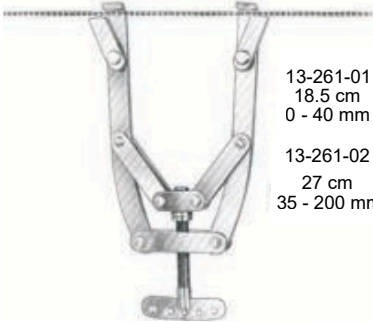

13-261-01  
 18.5 cm small pattern  
 0 - 40 mm  
 13-261-02  
 27 cm large pattern  
 35 - 200 mm

Kirschner

13-261-01 - 13-261-02



13-263- 18 x 10  
 18 13- cm 27 x  
 263-27 16 cm

with 3 traction hooks

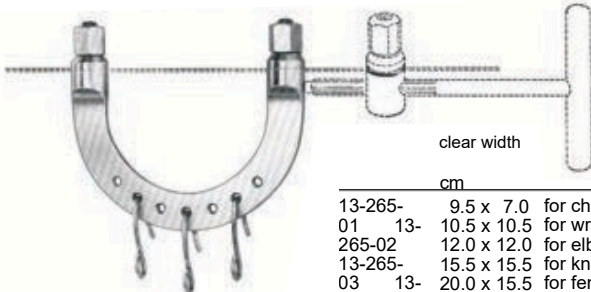

clear width

cm

13-265-01	13-	9.5 x 7.0	for children
265-02		10.5 x 10.5	for wrist & ankle
13-265-03	13-	12.0 x 12.0	for elbow
265-04		15.5 x 15.5	for knee
13-265-05	13-	20.0 x 15.5	for femur
266-01		6.0 x 5.0	
13-266-02	13-	9.5 x 11.0	
266-03		13.5 x 13.0	

Kirschner

13-265-01 - 13-266-03

for extension bow



1/1  
 Traction Hook  
 13-267-03



1/1  
 Traction Hook  
 13-267-06

Bone Surgery - Knochenchirurgie - Cirugía ósea  
 Bone Chisels and Gouges  
 Meißel und Osteotome  
 Cinceles y Gubias para huesos

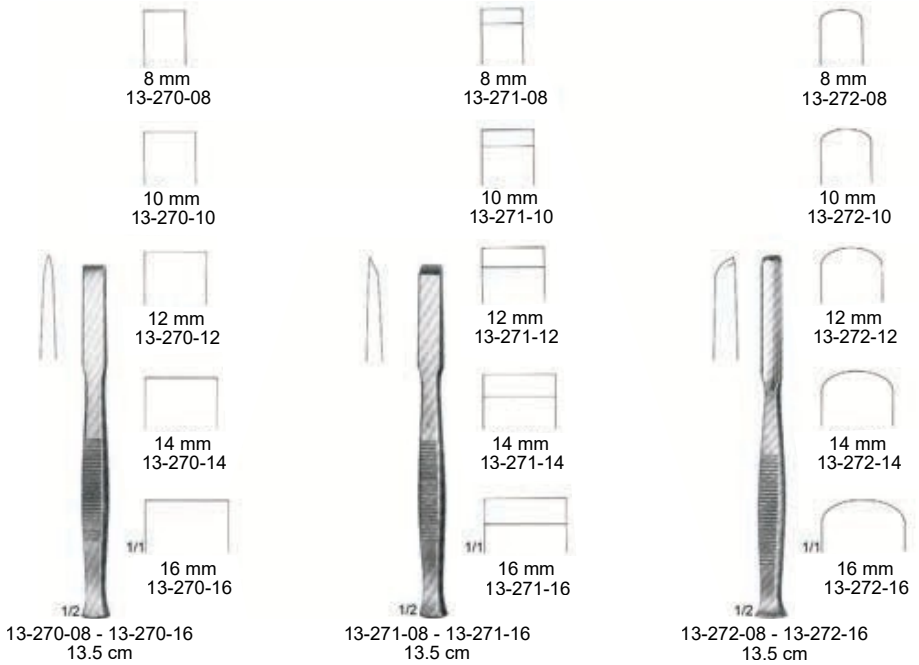

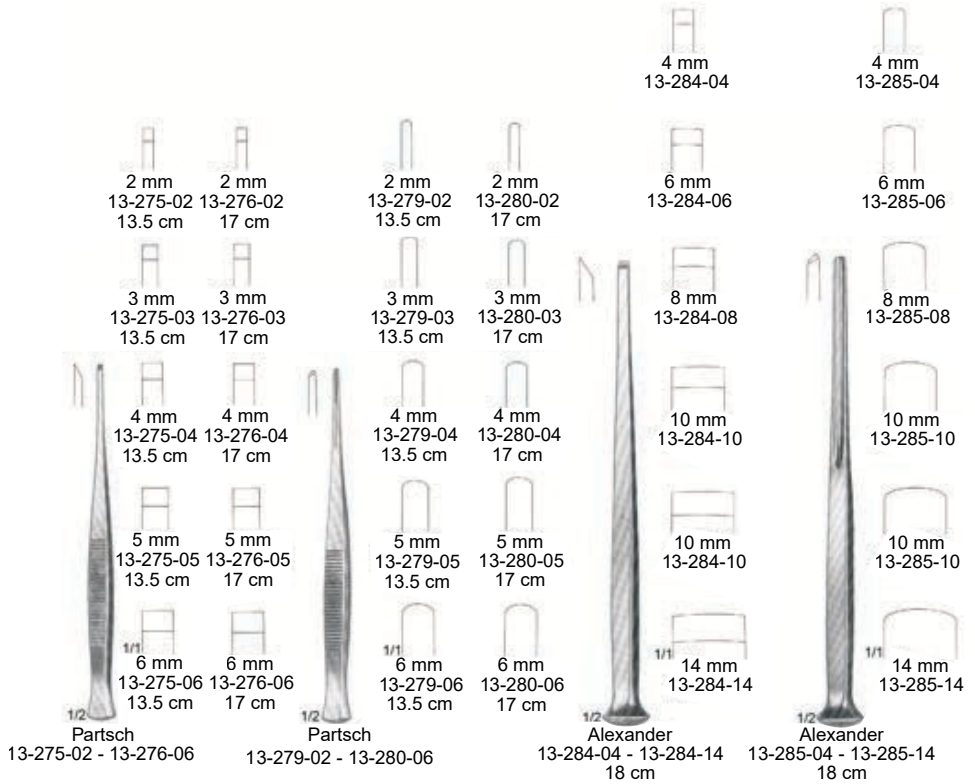

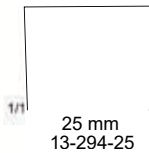
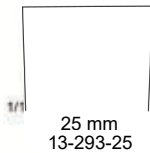
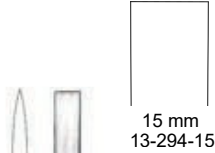
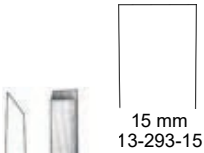
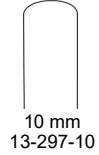
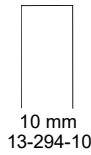
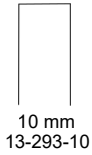

1/2  
**Stille**  
 13-293-10 - 13-293-25  
 20 cm

1/2  
**Stille**  
 13-294-10 - 13-294-25  
 20 cm

1/2  
**Stille**  
 13-297-10 - 13-297-25  
 20 cm

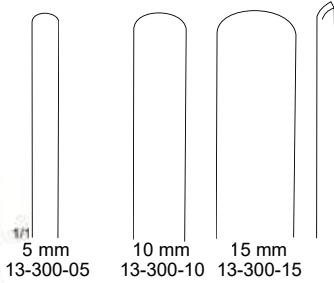

Lexer  
 13-300-05 - 13-300-15  
 25 cm

Handle from artificial wood

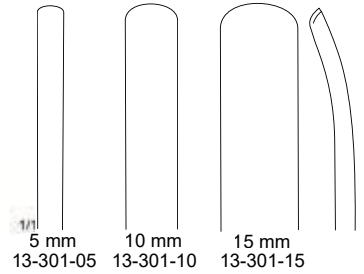

Lexer  
 13-301-05 - 13-301-15  
 25 cm

Handle from artificial wood

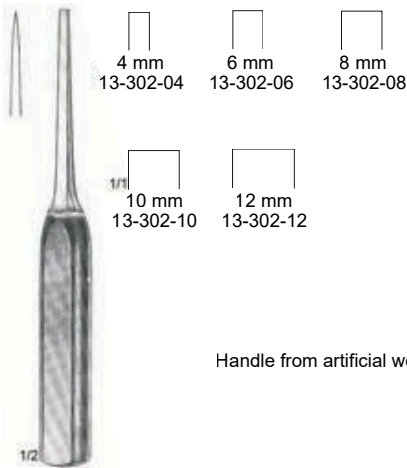

Mini - Lexer  
 13-302-04 - 13-302-12  
 18 cm

Handle from artificial wood

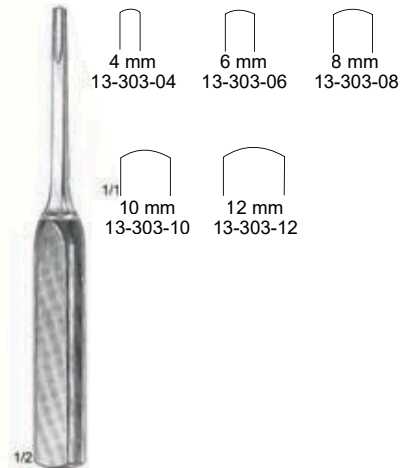

Mini - Lexer  
 13-303-04 - 13-303-12  
 18 cm

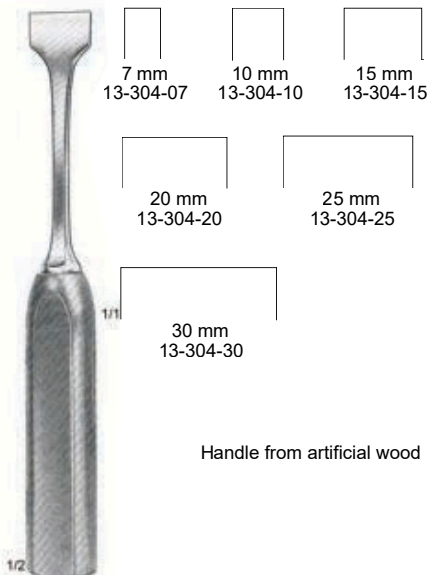

Lexer  
 13-304-07 - 13-304-30  
 22 cm

Handle from artificial wood

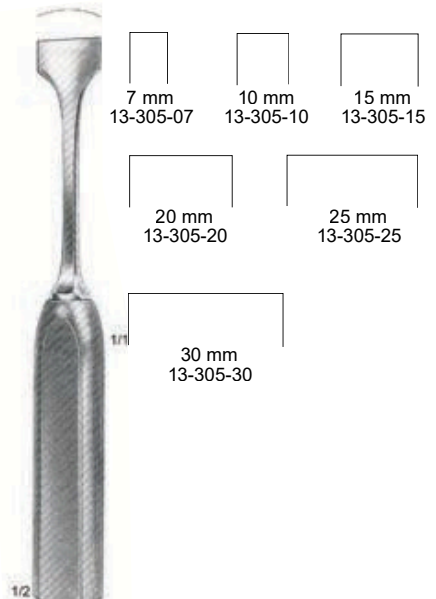

Lexer  
 13-305-07 - 13-305-30  
 22 cm



1/2  
 Lexer  
 27.5 cm

10  
 mm  
 15  
 mm

13-306-10  
 13-306-15

Handle from artificial wood



1/2  
 Lexer  
 27.5 cm

13-307-10  
 13-307-15

Handle of artificial wood



1/2  
Cobb  
13-310-01  
28 cm



1/2  
Cobb  
13-310-02  
28 cm



1/2  
Cobb  
13-310-03  
28 cm



1/2  
Cobb  
13-310-04  
28 cm

Handle from artificial wood



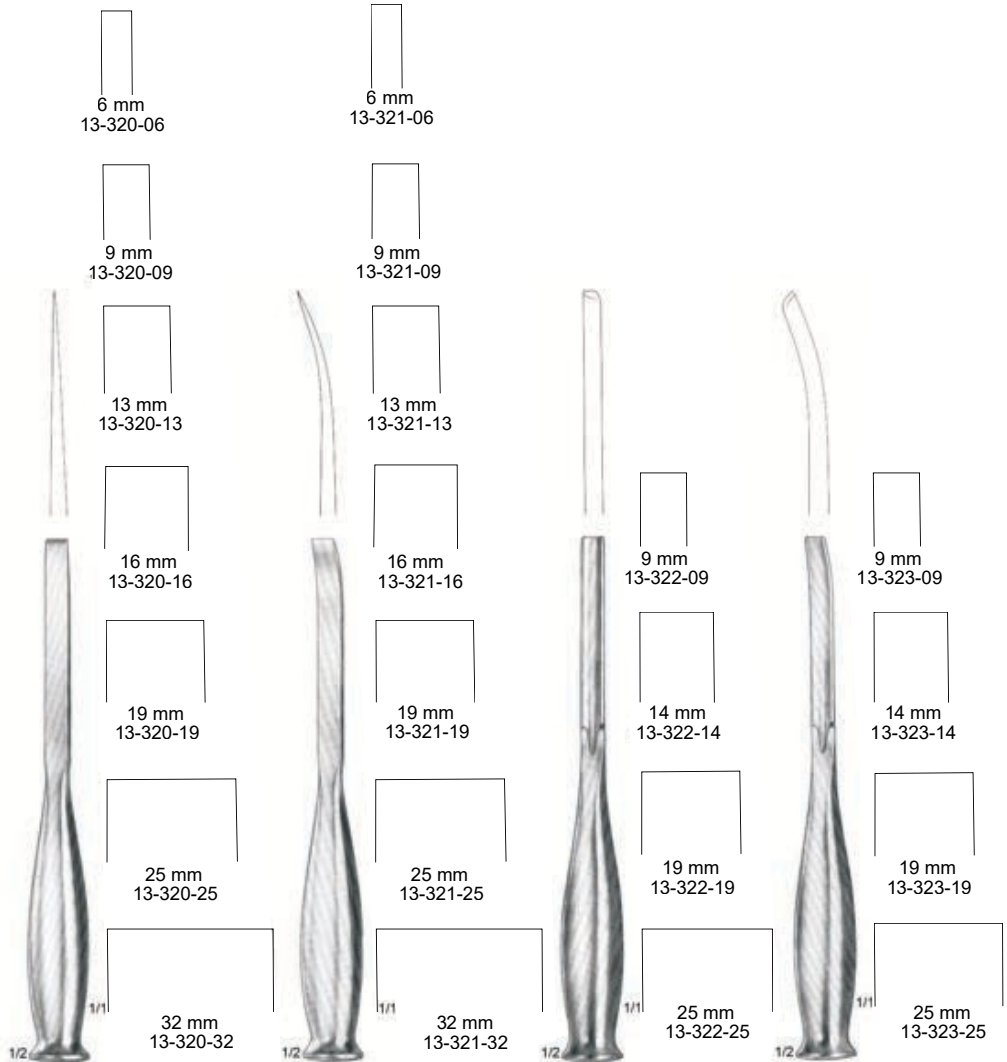

Smith - Petersen  
 13-320-06 - 13-323-25  
 20 cm



Hibbs  
24 cm

06 mm 13-333-06  
 13 mm 13-333-13  
 19 mm 13-333-19  
 25 mm 13-333-25  
 32 mm 13-333-32

13-334-06  
 13-334-13  
 13-334-19  
 13-334-25  
 13-334-32

13-335-06  
 13-335-13  
 13-335-19  
 13-335-25  
 13-335-32

13-336-06  
 13-336-13  
 13-336-19  
 13-336-25  
 13-336-32

13-337-06  
 13-337-13  
 13-337-19  
 13-337-25  
 13-337-32

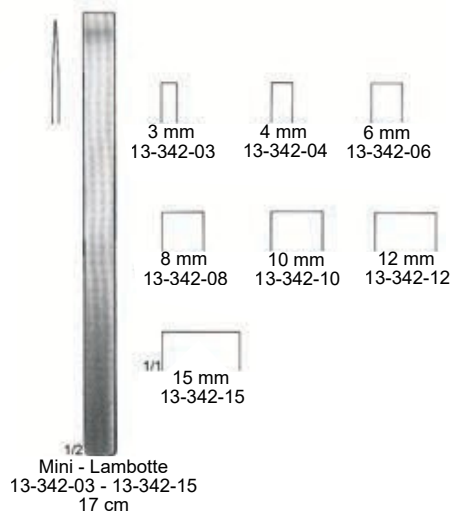
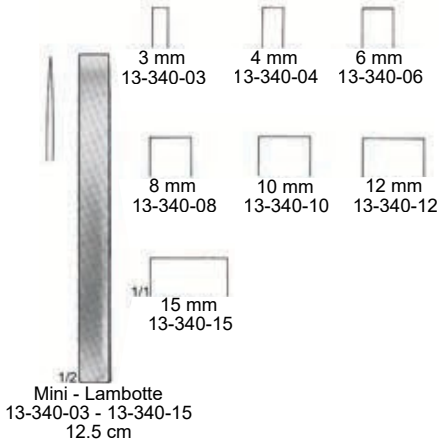

Bone Surgery -Knochenchirurgie - Cirugía ósea  
 Bone Chisels and Gouges  
 Meißel und Osteotome  
 Cinceles y Gubias para huesos

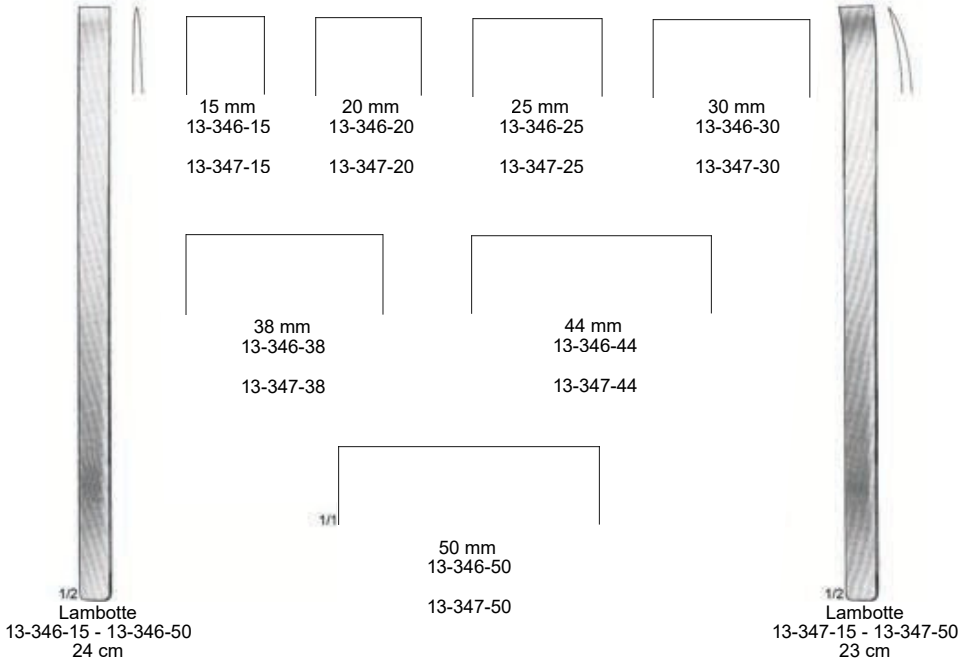

Bone Surgery - Knochenchirurgie - Cirugía ósea  
 Bone Chisels and Gouges, Bone Rasp  
 Meißel und Osteotome, Knochenra Speln  
 Cinceles y Gubias para huesos, Escofinas para Hueso

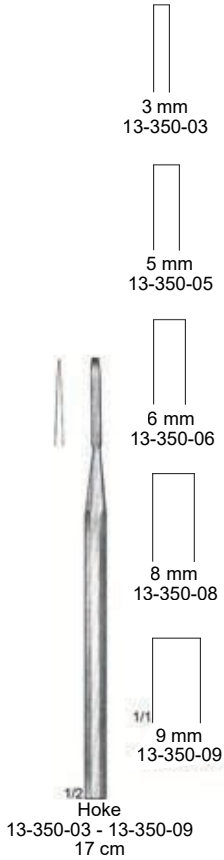

Lead Hand



13-360-01 - 13-360-02



Feldheim  
13-366-10  
10 cm



Ideal  
13-370-10

13-371-00 (13-371-01 + 13-371-02 + 13-371-03 + 13-370-10)



13-371-01



13-371-02



13-371-03

Bone Surgery -Knochenchirurgie - Cirugía ósea  
Mallets  
Hämmer  
Martillos y Mazos

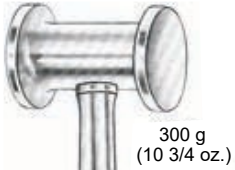

300 g  
(10 3/4 oz.)

1/2  
Bergmann  
13-400-24  
24 cm

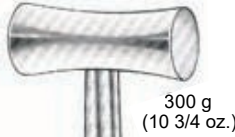

300 g  
(10 3/4 oz.)

1/2  
Bergmann  
13-402-23  
23 cm

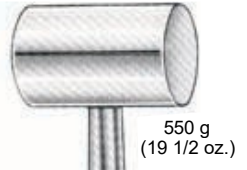

550 g  
(19 1/2 oz.)

1/2  
Ombredanne  
13-404-24  
24 cm

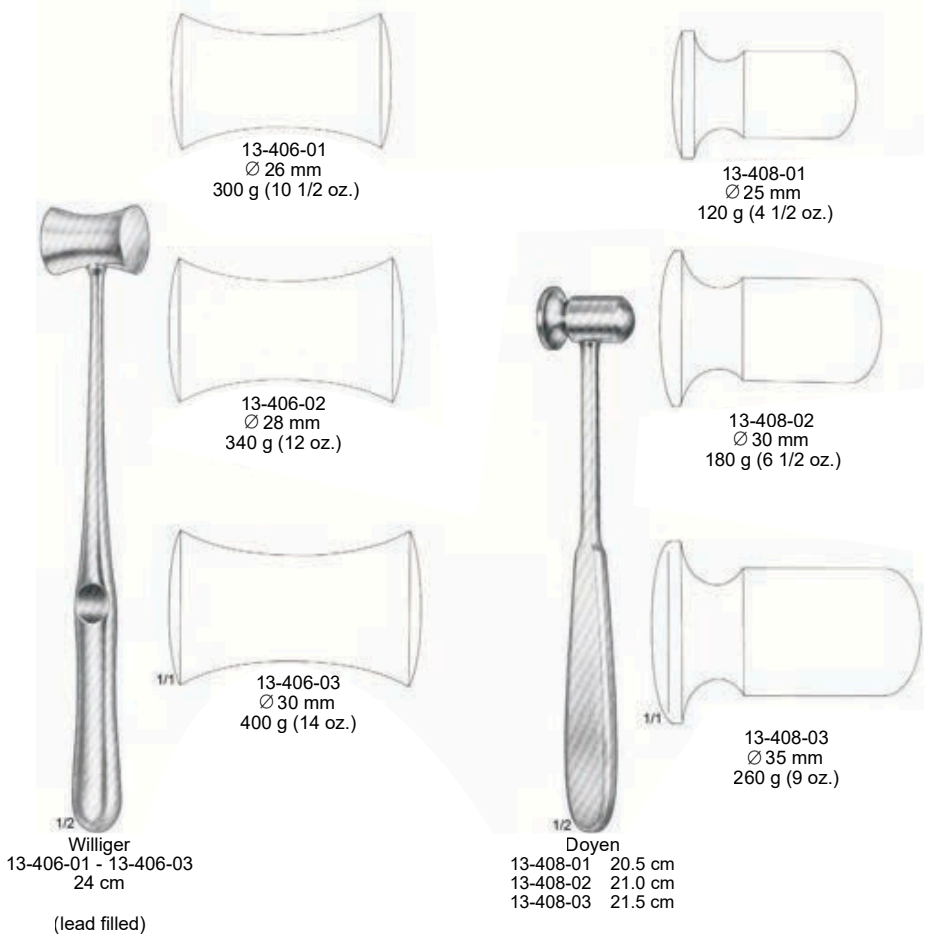

Bone Surgery -Knochenchirurgie - Cirugía ósea  
 Mallets  
 Hammer  
 Martillos y Mazos



Ø 30 mm  
 220 g (7 3/4 oz.)

1/2

Collin  
 13-410-20  
 20 cm



13-414-01  
 Ø 19 mm  
 230 g (8 oz.)

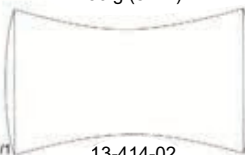

13-414-02  
 Ø 25 mm  
 260 g (9 oz.)

1/2

Lucae  
 13-414-01 - 13-414-02  
 19 cm



Ø 20 mm  
 140 g (5 oz.)

1/2

Williger  
 13-416-16  
 16.5 cm



Ø 30 mm  
450 g (16 oz.)

1/2  
13-420-26  
26.5 cm



Ø 50 mm  
900 g (32 oz.)

1/2  
13-422-26  
26.5 cm



Ø 42 mm  
Ø 30 mm  
530 g (19 oz.)

1/2  
13-424-24  
24.0 cm

Bone Surgery -Knochenchirurgie - Cirugía ósea  
Mallets  
Hämmer  
Martillos y Mazos



240 g (8 1/2 oz.)

1/2

Cottle  
13-430-19  
19 cm



Ø 80 x 60 mm  
400 g (14 1/4oz.)

1/2

Steinbach  
13-432-24  
24 cm

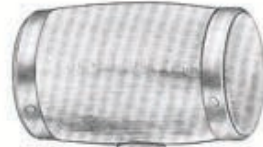

Ø 45 mm  
290 g (10 1/2 oz.)

1/2

13-434-23  
23 cm

Bone Surgery - Knochenchirurgie - Cirugía ósea  
Mallets  
Hämmer  
Martillos y Mazos



Ø 27 mm  
140 g (5 oz.)

1/2

Hajek  
13-440-22  
22 cm



Ø 26 mm  
140 g (5 oz.)

1/2

13-442-18  
18 cm



Ø 20 mm  
140 g (5 oz.)

1/2

Thiess  
13-444-16 - 13-445-16  
16.5 cm

Bone Surgery -Knochenchirurgie - Cirugía ósea  
 Mallets  
 Hammer  
 Martillos y Mazos



Ø 30 mm  
 510 g (18 oz.)

1/2

13-448-26  
 26 cm

with interchangeable  
 Ferrozell faces

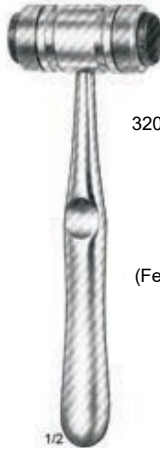

Ø 26 mm  
 320 g (11 1/4oz.)

1/2

Mead  
 13-450-17 - 13-451-17  
 17 cm

13-450-17  
 (solid)

13-451-17  
 (Ferozell Faces)



Ø 22 mm  
 200 g (7 oz.)

1/2

Partsch  
 13-454-18  
 18 cm



Ø 42 mm

13-456-01 250 g  
(plastic, lead filled)

13-456-02 400 g  
(Ferrozell, without lead)

1/2

13-456-01 - 13-456-02  
26 cm



Ø 42 mm  
400 g

1/2

13-458-26  
26 cm  
(Ferrozell, lead filled)



Ø 30 mm  
675 g

1/2

13-460-26  
26 cm  
(repercussion free)

Bone Surgery -Knochenchirurgie - Cirugía ósea  
 Mallets  
 Hämmer  
 Martillos y Mazos



1/2  
 13-467-00

Spare Faces, pair



Ø 42 mm  
 530 g (19 oz.)      Ø 30 mm

1/2  
 13-462-26  
 26 cm  
 (steel, solid)

(with plastic handle)



Ø 30 mm  
 480 g

1/2  
 13-464-24  
 24 cm  
 (steel, solid)

(with plastic handle)



Ø 37 mm  
 370 g

1/2  
 13-466-22  
 22.5 cm  
 (steel, solid)

(with Ferrozell faces)



Ø 30 mm  
 125 g (4 oz.)

1/2  
 13-468-18  
 18 cm  
 (Ferozell, solid)

(Ferozell, solid)



13-470-01  
26 cm  
(steel, solid)



13-470-02  
26 cm  
(steel, solid)

with interchangeable plastic disks  
pair of spare disks



Vickers  
13-472-19  
19 cm

Bone Surgery - Knochenchirurgie - Cirugía ósea  
 Mallets  
 Hämmer  
 Martillos y Mazos

- 13-480-01 300 g
- 13-480-02 500 g
- 13-480-03 600 g
- 13-480-04 940 g





Fig. 000 13-500-30  
 Fig. 00 13-500-20  
 Fig. 0 13-500-10

Fig. 0000 13-502-40  
 Fig. 000 13-502-30  
 Fig. 00 13-502-20

Fig. 1 13-501-01  
 Fig. 2 13-501-02  
 Fig. 3 13-501-03

Fig. 0 13-502-10  
 Fig. 1 13-503-01  
 Fig. 2 13-503-02

Fig. 4 13-501-04

Fig. 3 13-503-03  
 Fig. 4 13-503-04  
 Fig. 5 13-503-05

Fig. 6 13-503-06



1/2  
 Schede  
 13-500-10 - 13-501-04  
 17 cm



1/2  
 Volkmann  
 13-502-10 - 13-503-06  
 17 cm

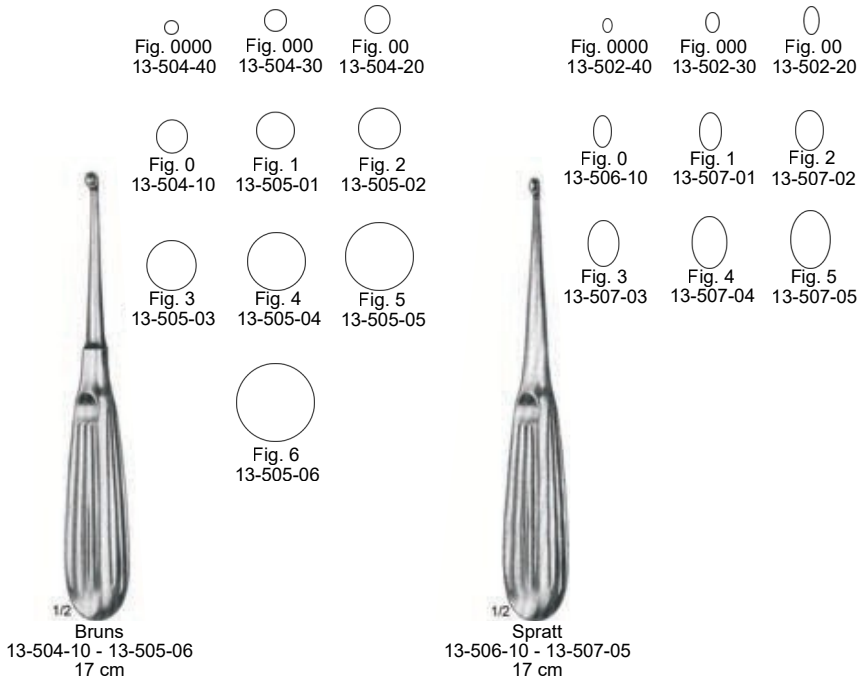

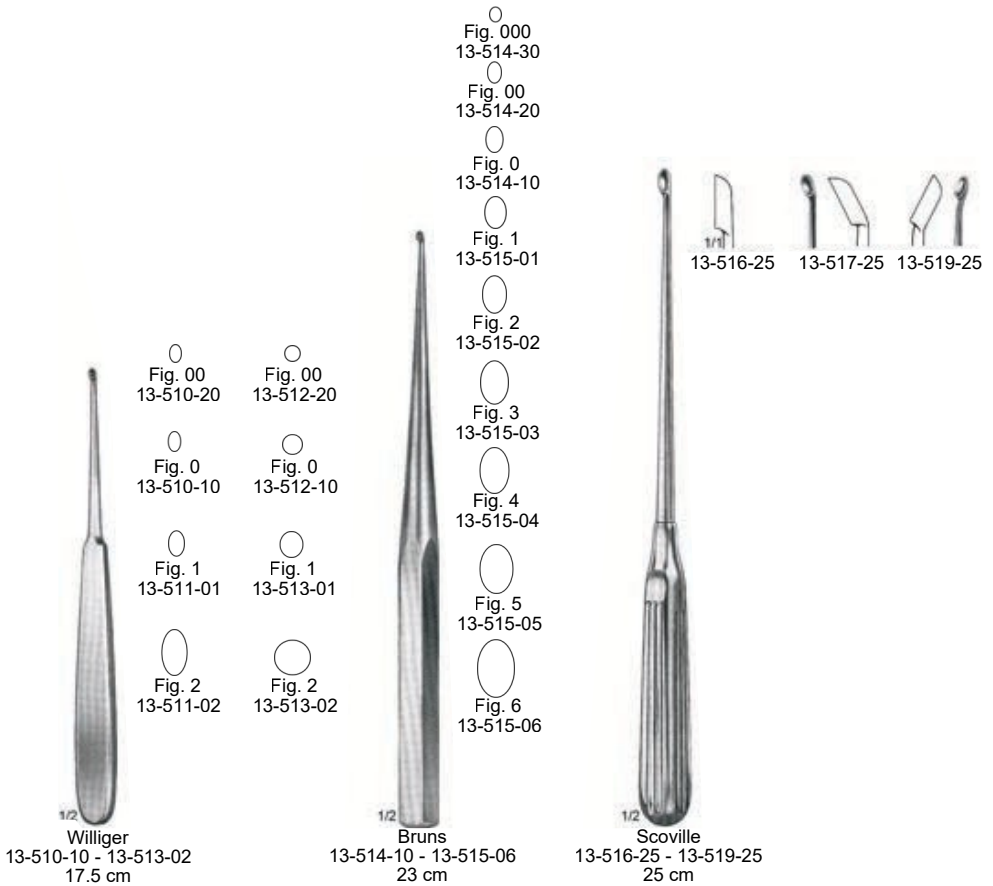

Fig. 000  
13-520-00

Fig. 3  
13-524-03

Fig. 000  
13-521-00

Fig. 3  
13-525-03

Fig. 00  
13-522-00

Fig. 4  
13-524-04

Fig. 00  
13-523-00

Fig. 4  
13-525-04

Fig. 0  
13-524-00

Fig. 5  
13-524-05

Fig. 0  
13-525-00

Fig. 5  
13-525-05

Fig. 1  
13-524-01

Fig. 1  
13-525-01

Fig. 2  
13-524-02

Fig. 6  
13-524-06

Fig. 2  
13-525-02

Fig. 6  
13-525-06



1/2

Cloward Hibbs Spratt Spinal Fusion  
13-520-00 - 13-524-06  
22.5 cm



1/2

Cloward Hibbs Spratt Spinal Fusion  
13-521-00 - 13-525-06  
22.5 cm



1/2  
 Uffenorde  
 13-527-01  
 17 cm



1/2  
 Uffenorde  
 13-527-02  
 17 cm



1/2  
 Daubenspeck  
 13-528-20 - 13-529-02  
 20 cm



Bone Surgery - Knochenchirurgie - Chirurgia ósea  
Bone Curettes  
Scharfe Löffel  
Cucharillas cortantes



13-530-00 - 13-530-03  
25 cm

3.6 mm  
13-530-00

4.4 mm  
13-530-01

5.2 mm  
13-530-02

6.0 mm  
13-530-03



13-531-00 - 13-531-03  
25 cm

3.6 mm  
13-531-00

4.4 mm  
13-531-01

5.2 mm  
13-531-02

6.0 mm  
13-531-03

Bone Surgery -Knochenchirurgie - Cirurgia ósea  
 Bone Currettes  
 Scharfe Löffel  
 Cucharillas cortantes

13-534-00  
 3.0 x 5.0 mm

13-536-00  
 3.0 x 5.0 mm

13-538-00  
 4.06 x 5.08 mm

13-534-01  
 3.5 x 5.5 mm

13-536-01  
 3.5 x 5.5 mm

13-538-01  
 5.08 x 6.35 mm

13-534-02  
 4.5 x 6.4 mm

13-536-02  
 4.5 x 6.4 mm

13-538-02  
 6.10 x 7.62 mm

13-534-03  
 5.0 x 8.0 mm

13-536-03  
 5.0 x 8.0 mm

13-538-03  
 7.11 x 8.89 mm

13-534-04  
 6.0 x 9.0 mm

13-536-03  
 5.0 x 8.0 mm

13-538-04  
 8.13 x 10.16 mm

13-534-05  
 7.0 x 11.0 mm

13-536-05  
 7.0 x 11.0 mm

13-538-05  
 9.14 x 11.43 mm

13-534-06  
 8.5 x 12.5 mm

13-536-06  
 8.5 x 12.5 mm

13-538-06  
 10.16 x 12.70 mm

13-534-07  
 9.5 x 14.5 mm

13-536-07  
 9.5 x 14.5 mm

13-538-07  
 11.18 x 13.97 mm

13-534-08  
 10.5 x 16.8 mm

13-536-08  
 10.5 x 16.8 mm

13-538-08  
 12.19 x 15.24 mm



1/2 Hatfield  
 13-534-00 - 13-534-08  
 23 cm



1/2 Hatfield  
 13-536-00 - 13-536-08  
 28 cm



1/2 Cobb  
 13-538-00 - 13-538-08  
 28 cm



- Fig. 1  
13-540-01
- Fig. 2  
13-540-02
- Fig. 3  
13-540-03
- Fig. 4  
13-540-04
- Fig. 5  
13-540-05
- Fig. 6  
13-540-06

Simon 13-540-01 - 13-540-06 24 cm



Mod. USA  
 13-542-01 - 13-545-06  
 16 cm



Fig. 1  
13-542-01



Fig. 2  
13-542-02



Fig. 3  
13-542-03



Fig. 4  
13-542-04



Fig. 5  
13-542-05



Fig. 6  
13-542-06



Fig. 1  
13-543-01



Fig. 2  
13-543-02



Fig. 3  
13-543-03



Fig. 4  
13-543-04



Fig. 5  
13-543-05



Fig. 6  
13-543-06



Fig. 1  
13-545-01



Fig. 2  
13-545-02



Fig. 3  
13-545-03



Fig. 4  
13-545-04



Fig. 5  
13-545-05

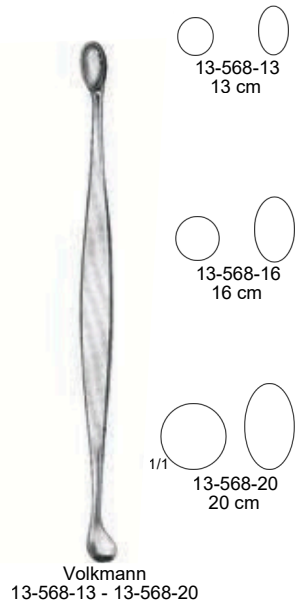
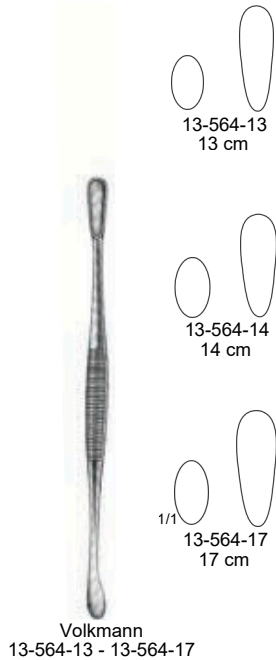
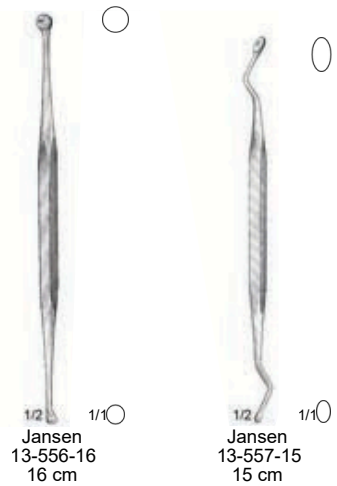
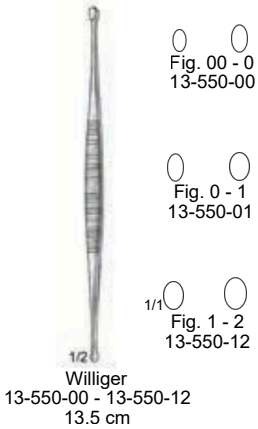

Fig. 6  
13-545-06



- Fig. 1  
13-548-01
- Fig. 2  
13-548-02
- Fig. 3  
13-548-03

Halle  
 13-548-01 - 13-548-03  
 21 cm



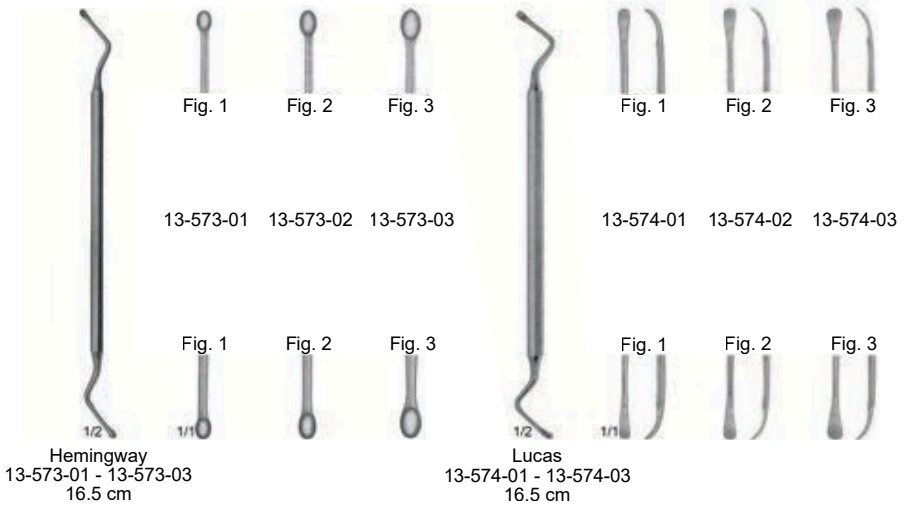
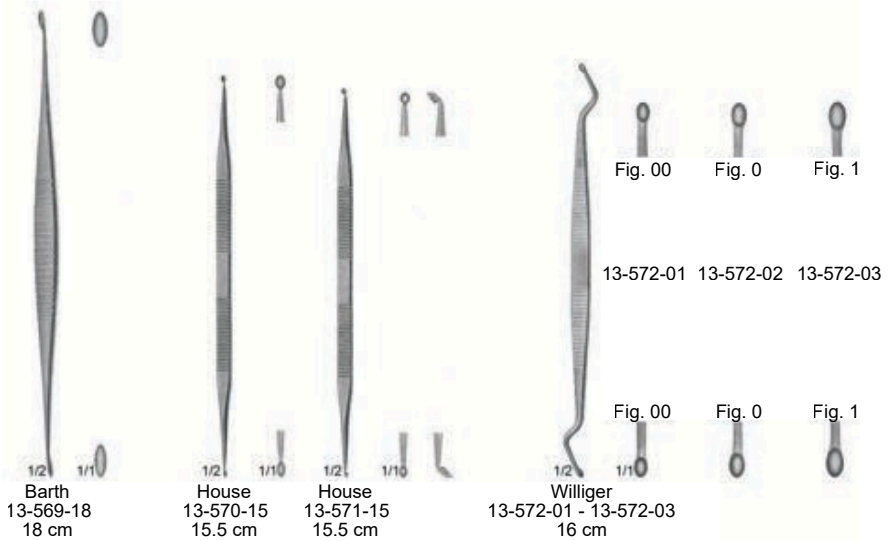

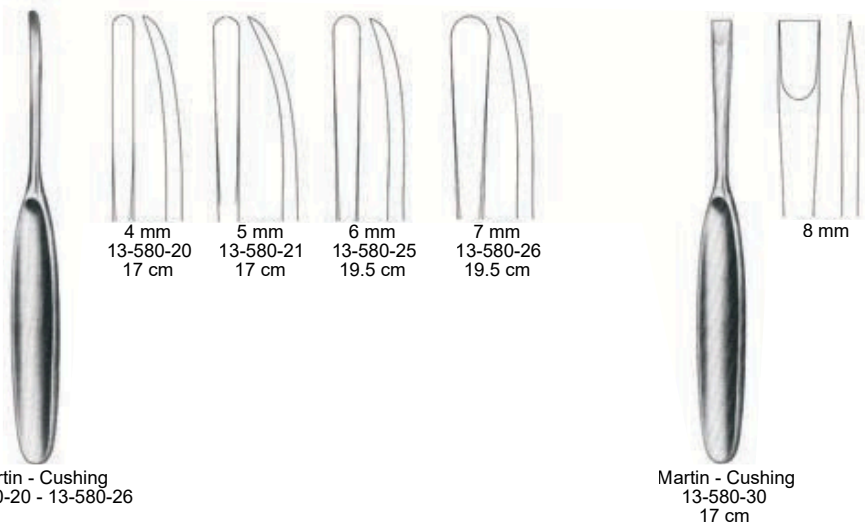

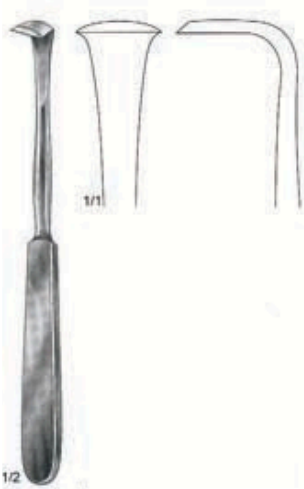

1/2  
 Langenbeck  
 13-591-18  
 18 cm

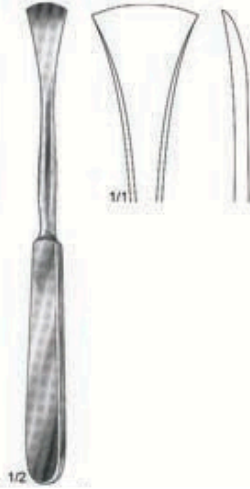

1/2  
 Langenbeck  
 13-593-19  
 19 cm

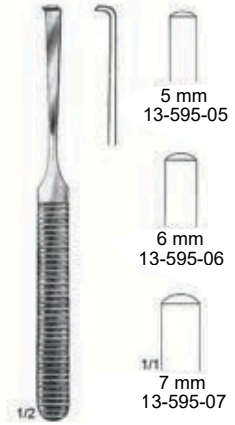

5 mm  
 13-595-05  
 6 mm  
 13-595-06  
 7 mm  
 13-595-07  
 1/2  
 13-595-05 - 13-595-07  
 16 cm

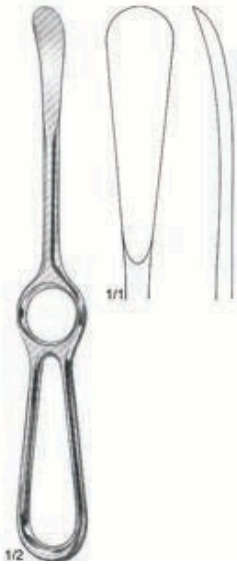

1/2  
 Sedillot  
 13-597-21  
 21 cm

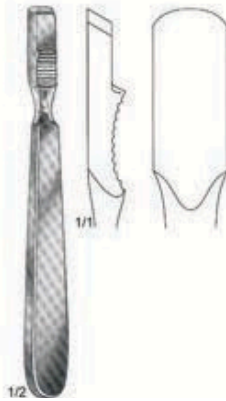

1/2  
 Farabeuf  
 13-598-15  
 15 cm

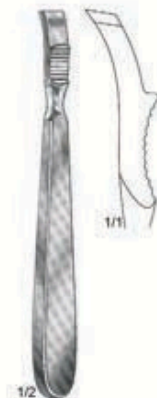

1/2  
 Farabeuf  
 13-599-15  
 15 cm



Schneider  
 13-581-17  
 17.5 cm



Schneider - Sauerbruch  
 13-581-19  
 19 cm



Farabeuf - Collin  
 13-582-15  
 15.5 cm



Farabeuf - Collin  
 13-583-15  
 15.5 cm



Handle from artificial wood



21 mm



Cobb  
13-585-10 - 13-585-25  
25 cm

13-587-27  
27.5 cm

Wagner  
13-589-08 - 13-589-17  
33 cm

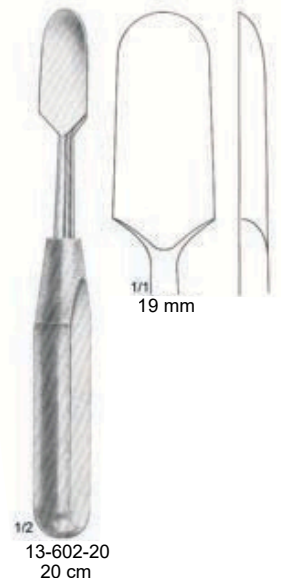

Handle from artificial wood

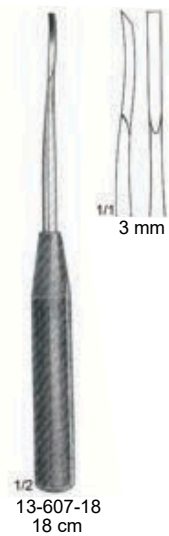

Bone Surgery - Knochenchirurgie - Cirugía ósea  
 Periosteal Raspatories  
 Raspatorien  
 Legras-Periostotomos

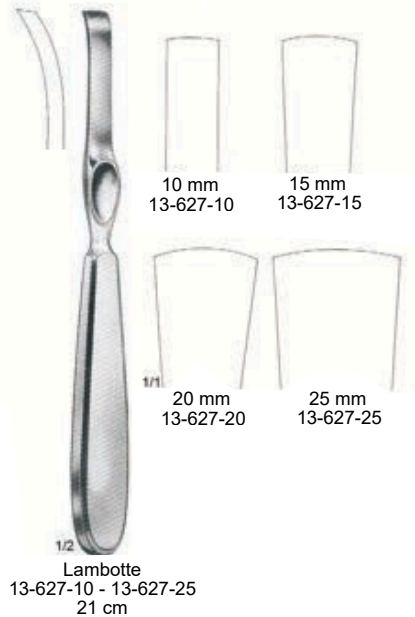
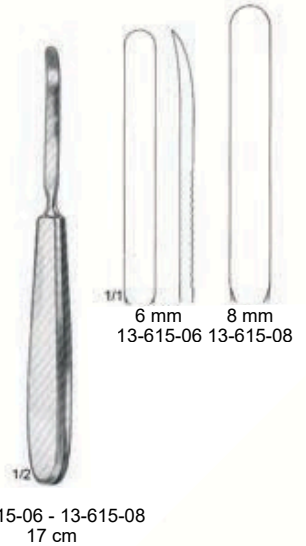
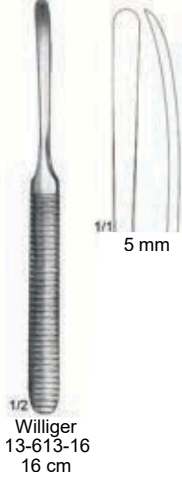
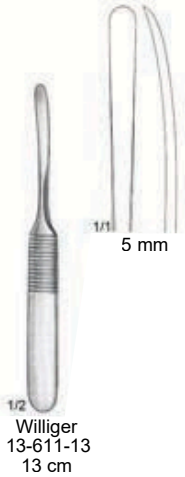



1/2  
 Semb  
 13-630-01 - 13-630-05

12 mm

1/2

Fig. 1  
 13-630-01  
 18.5 cm

12 mm



Fig. 2  
 13-630-02  
 23 cm

13 mm



Fig. 3  
 13-630-03  
 18.5 cm

13 mm



Fig. 4  
 13-630-04  
 23 cm

15 mm



Fig. 5  
 13-630-05  
 21.5 cm

Bone Surgery -Knochenchirurgie - Cirurgia ósea  
 Periosteal Raspatories  
 Raspatorien  
 Legras-Periostotomos



12 mm  
 1/2  
 Fig. 1  
 13-632-01  
 17.5 cm



12 mm  
 Fig. 2  
 13-632-02  
 21 cm



13 mm  
 Fig. 3  
 13-632-03  
 17.5 cm



13 mm  
 Fig. 4  
 13-632-04  
 21 cm



15 mm  
 Fig. 5  
 13-632-05  
 20.5 cm

1/2  
 Semb  
 13-632-01 - 13-632-05



1/2  
 Alexander  
 13-634-20  
 20 cm



1/2  
 Matson  
 13-636-22  
 22 cm

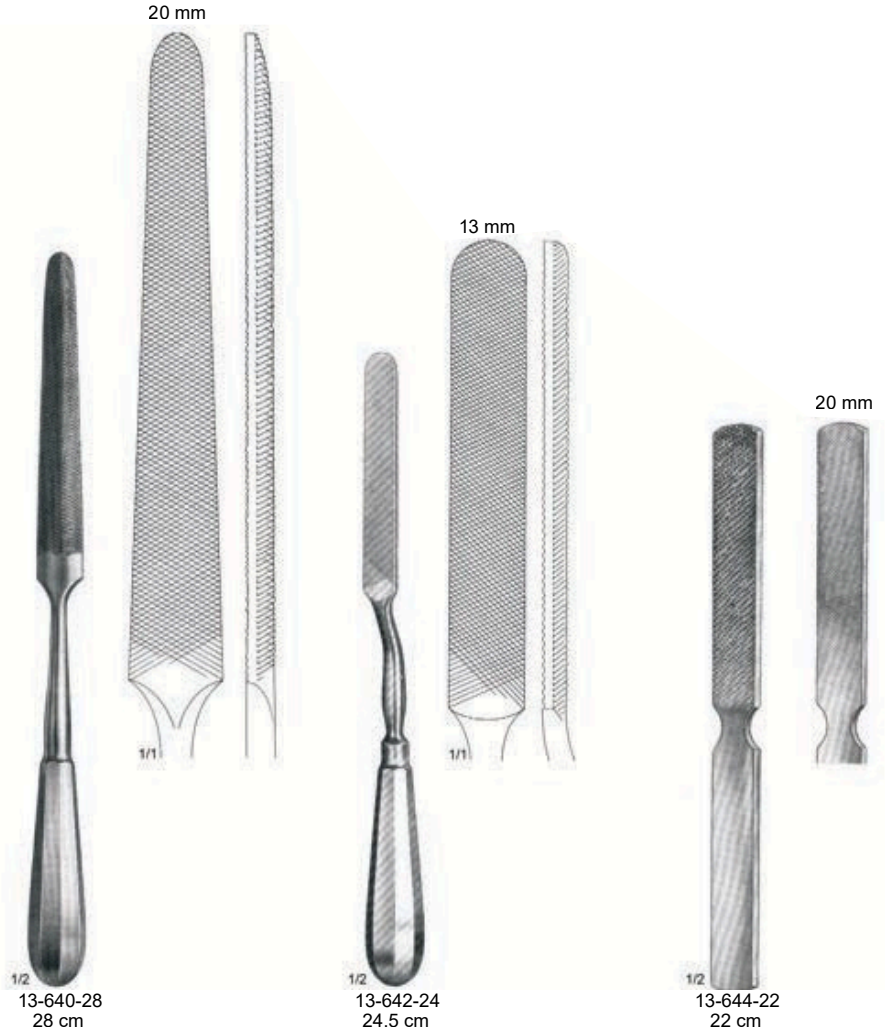



13-648-02  
Ø 2 mm



13-648-03  
Ø 3 mm



13-648-04  
Ø 4 mm



13-648-05  
Ø 5 mm



13-648-06  
Ø 6 mm



13-648-08  
Ø 8 mm



1/1  
13-648-10  
Ø 10 mm



12  
13-648-02 - 13-648-10  
15.5 cm

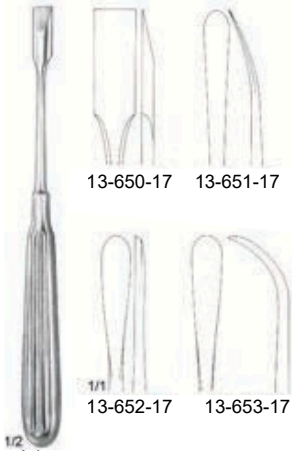

Adson  
 13-650-17 - 13-653-17  
 17 cm

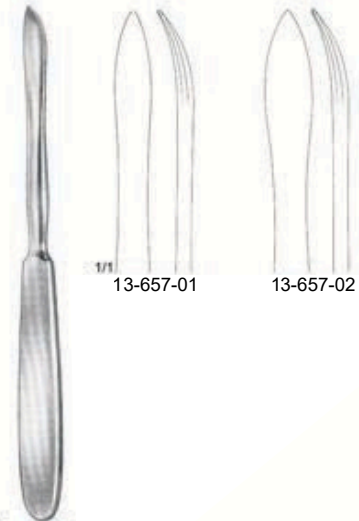

Langenbeck  
 13-657-01 - 13-657-02  
 19 cm



Williger  
 13-661-17  
 17 cm

Williger  
 13-663-16  
 16 cm

Martin-Langenbeck  
 13-667-01 - 13-667-04

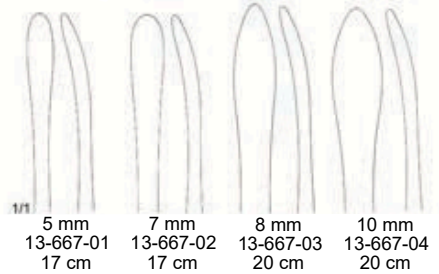

5 mm  
 13-667-01  
 17 cm

7 mm  
 13-667-02  
 17 cm

8 mm  
 13-667-03  
 20 cm

10 mm  
 13-667-04  
 20 cm



9.5 mm  
 13-670-01



13 mm  
 13-670-02



1/1  
 19 mm  
 13-670-03



1/2  
 Cobb  
 13-670-01 - 13-670-03  
 28 cm



1/2  
 Langenbeck  
 13-673-23  
 23 cm

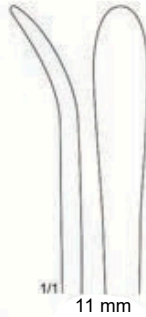

1/1  
 11 mm

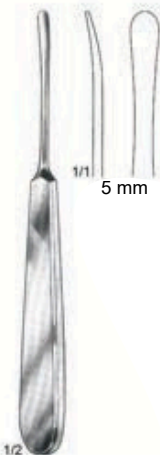

1/2  
 Sebilleau  
 13-675-17  
 17.5 cm



1/2  
 Vickers  
 13-677-17  
 17 cm



1/2  
 Vickers  
 13-679-17  
 17 cm



1/2  
 13-681-17  
 17.5 cm



1/2  
 13-683-16  
 16 cm



1/2  
 13-685-16  
 16 cm



1/2  
 Alderdyce  
 13-687-21  
 21 cm



1/2  
 McDonald  
 13-689-19  
 19 cm



13-690-14  
14 cm

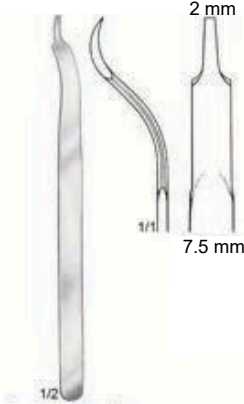

Buck - Gramcko  
13-690-15  
15 cm

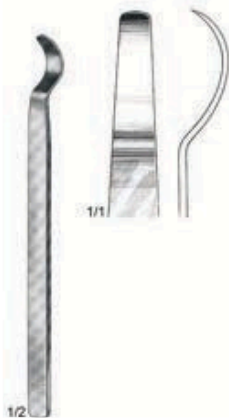
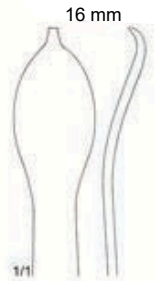

13-691-14  
14 cm



6 mm  
13-693-06



8 mm  
13-693-08



13-693-15  
16 cm



13-693-16  
12 cm

Mini-Hohmann  
13-693-06 - 13-693-08  
16 cm

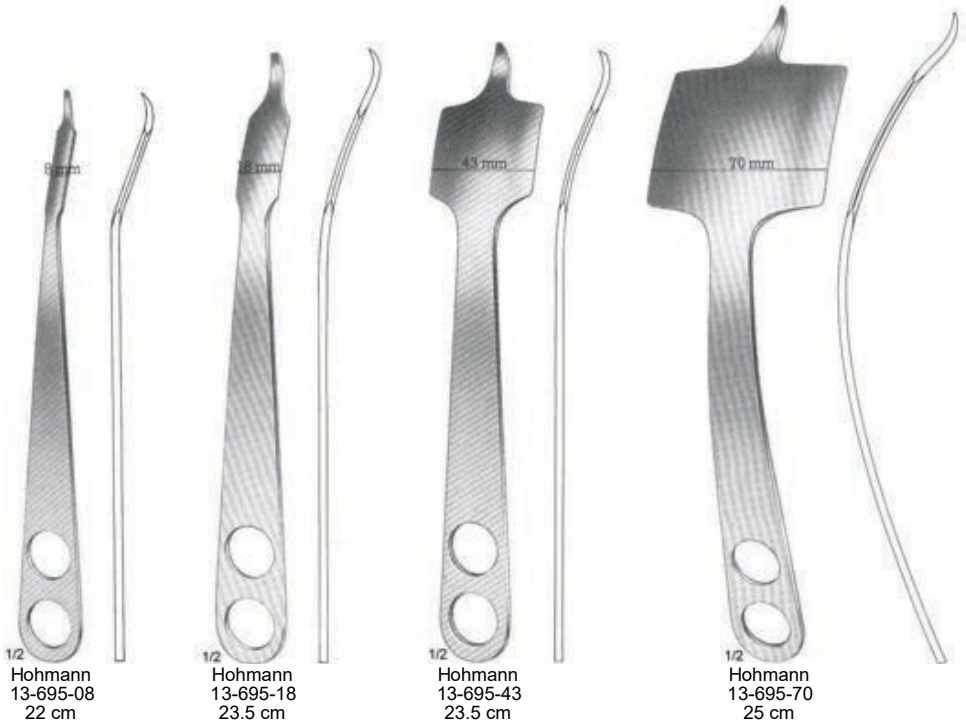

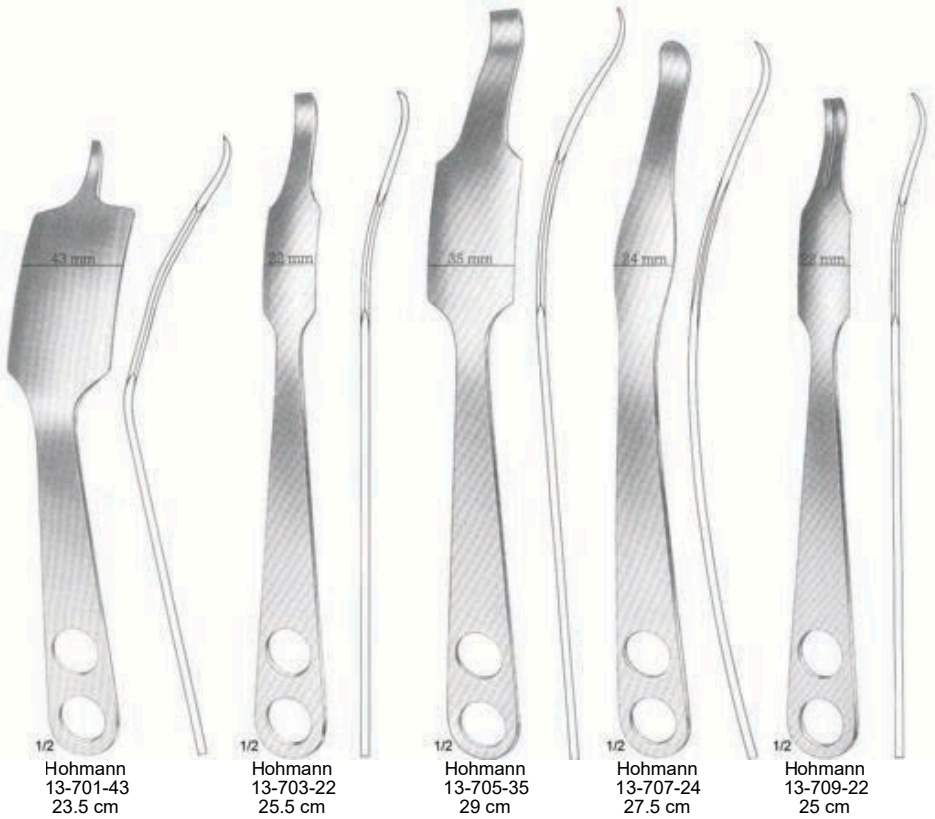



Bennett  
13-711-43 - 13-711-60  
24 cm

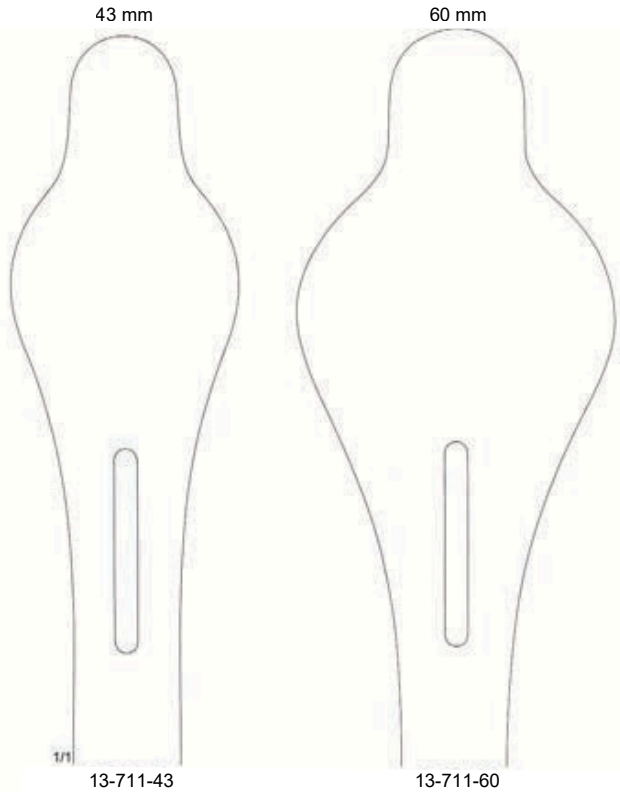

13-712-01 13-712-02  
 26.5 cm 29 cm  
 30 mm 33 mm



Lange - Hohmann Modif  
 13-712-01 - 13-712-02



Hohmann - Aldinger  
 13-712-03  
 27 cm



Schumacher  
 13-712-04  
 34.5 cm  
 (Wagner)



Schumacher  
 13-712-05  
 29 cm

13-713-01  
 32 x 19 mm

13-713-02  
 48 x 19 mm

13-713-03  
 57 x 19 mm



Smillie  
 13-713-01 - 13-713-05  
 14 cm



13-713-04  
 52 x 13 mm



13-713-05  
 12 x 13 mm



Wagner  
 13-713-06  
 22 cm



Murphy - Lane  
 13-713-07  
 32 cm

13-713-08  
 18 cm 13 mm

13-713-09  
 20 cm 19 mm

13-713-10  
 23 cm 25 mm

13-713-11  
 25 cm 30 mm



Chandler  
 13-713-08 - 13-713-11

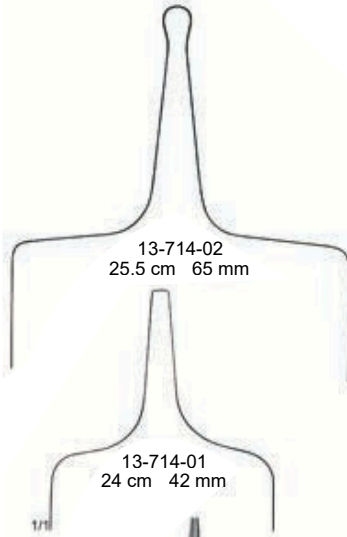

Verbrugge - Müller  
13-714-01 - 13-714-02



Lane Trethowan  
13-714-03  
21.5 cm



Lane  
13-714-04  
25.5 cm

Bone Surgery -Knochenchirurgie - Cirugía ósea  
 Bone Levers  
 Knochenheber  
 Elevadores para huesos



1/3  
 Blount  
 13-715-26  
 26 cm



1/3  
 Blount  
 13-717-26  
 26 cm

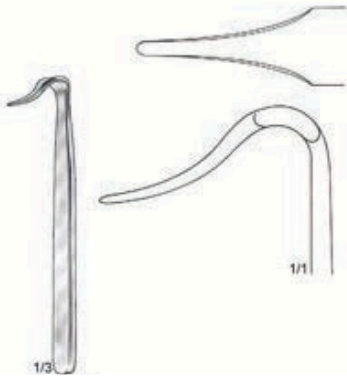

1/3  
 Schumacher  
 13-712-04  
 34.5 cm

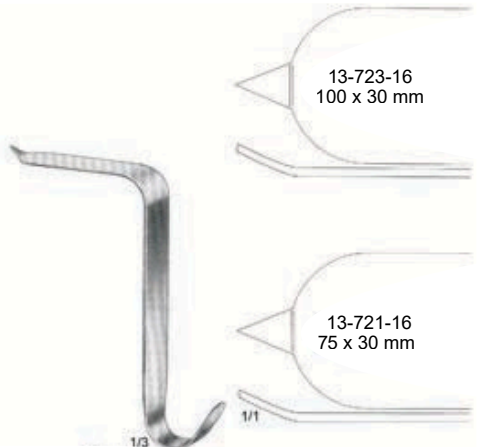

1/3  
 Taylor  
 13-721-16 - 13-723-16  
 16.5 cm

13-723-16  
 100 x 30 mm

13-721-16  
 75 x 30 mm

Bone Surgery -Knochenchirurgie - Cirurgia ósea  
 Meniscotomy Knives  
 Meniskotome  
 Bisturles para meniscos



13-725-19 13-727-19

30 mm 33 mm

1/2

Bircher

13-725-19 - 13-727-19  
19 cm

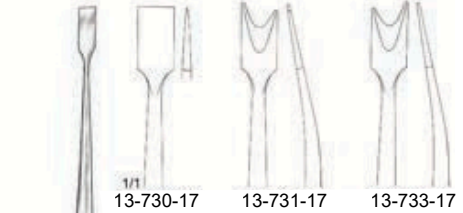

13-730-17 13-731-17 13-733-17

1/2

Smillie

13-730-17 - 13-733-17  
17 cm

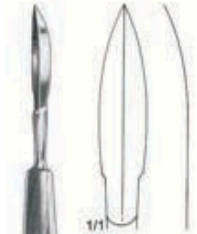

1/1

1/2

13-735-18  
18 cm



1/2

Neff

13-737-22 - 13-739-22  
22 cm

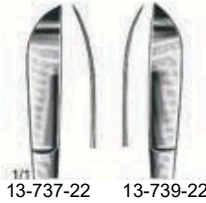

13-737-22 13-739-22

Left

Right



1/2

Salenius  
13-740-22  
22 cm



1/2

Salenius  
13-741-22  
22 cm

Bone Surgery - Knochenchirurgie - Cirugía ósea  
 Tendon Stripper, Tendon Tunnel Instruments  
 Sehnenstripper, Durchzugsinstrumente  
 Separafiores para tendones

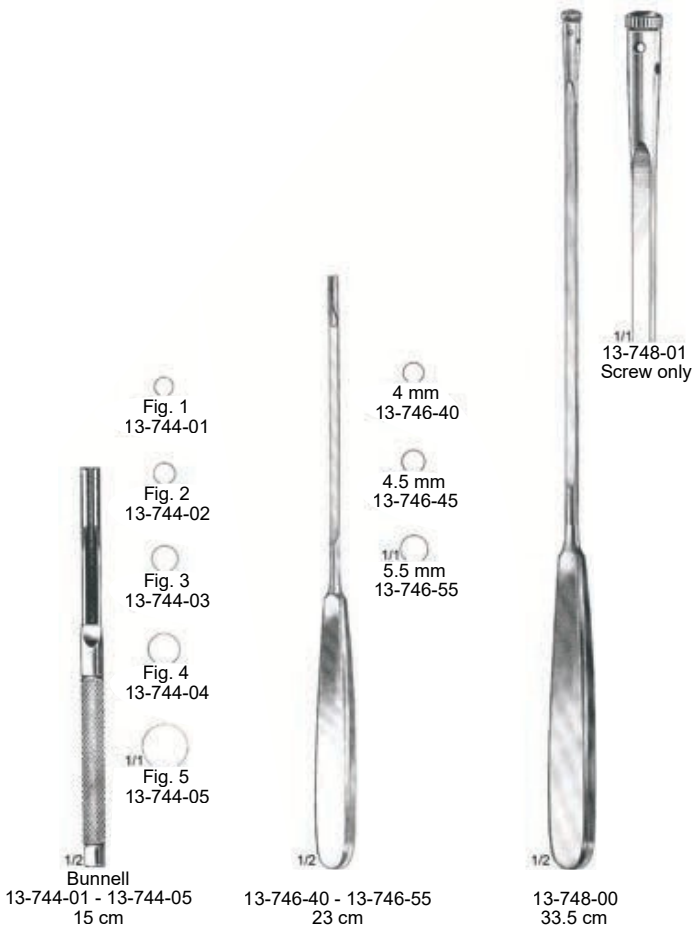



1/2  
Fischer  
13-750-31  
31 cm



1/2  
13-752-28  
28 cm



1/2  
Bunnel  
13-754-28  
28 cm

malleable

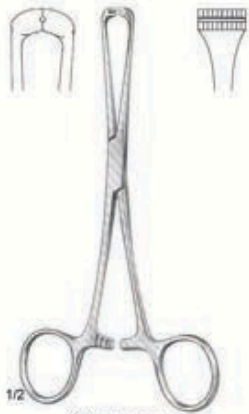

Steinmann  
 13-758-16  
 16 cm



Brand  
 13-760-15 - 13-760-24

13-760-15  
 15 cm

13-760-19  
 19 cm

13-760-24  
 24 cm

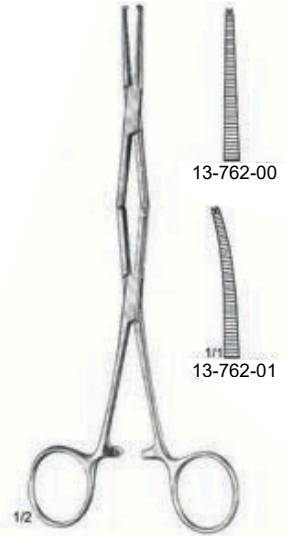

13-762-00 - 13-762-01  
 20.5 cm

13-762-00

13-762-01

Fine Serrations

Coarse Serrations

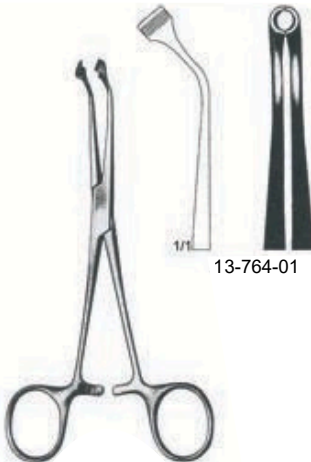

Herz  
 13-764-01 - 13-764-02  
 15.5 cm

13-764-01

13-764-02



Caroll  
 13-765-11  
 11 cm

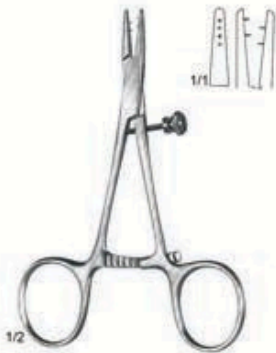

13-766-13  
13 cm



Kleinert-Kutz  
13-767-20  
20 cm

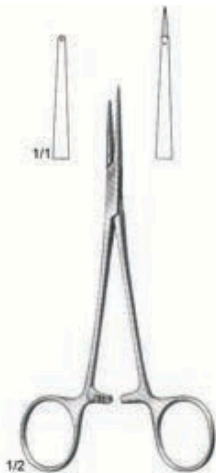

13-768-15  
15 cm

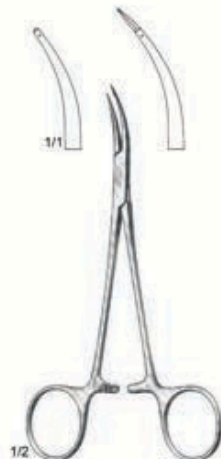

13-769-15  
15 cm

Bone Surgery - Knochenchirurgie - Cirugía ósea  
 Reposition Forceps      Forceps,  
 Sequester Forceps  
 Repositionszangen,      Sequesterzangen  
 Pinzas para huesos y para secuestros



Reill  
 13-770-20  
 20 cm



Meyer  
 13-772-17  
 17 cm

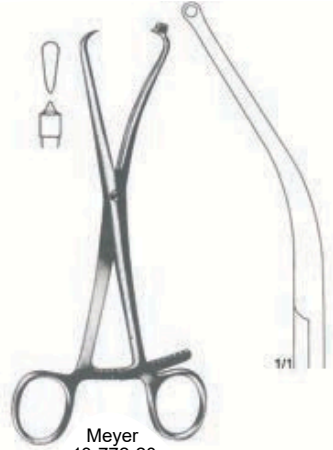

Meyer  
 13-772-20  
 20.5 cm

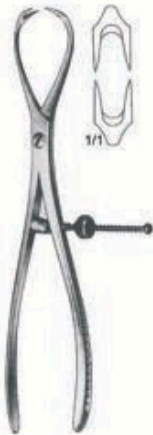

Patella  
 13-774-18  
 18 cm



13-776-20 - 13-777-20  
 20 cm



13-776-20



13-777-20

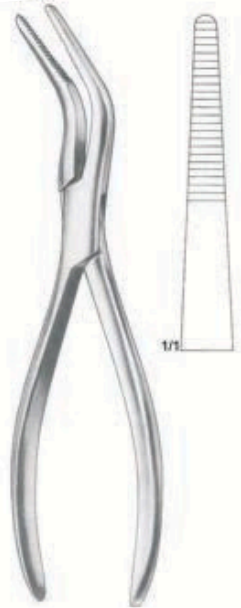

Van Buren  
 13-778-23  
 23cm

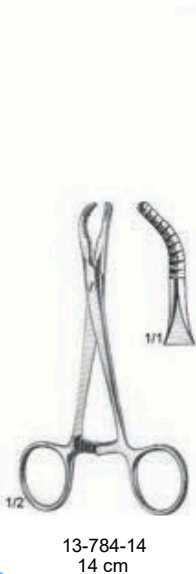
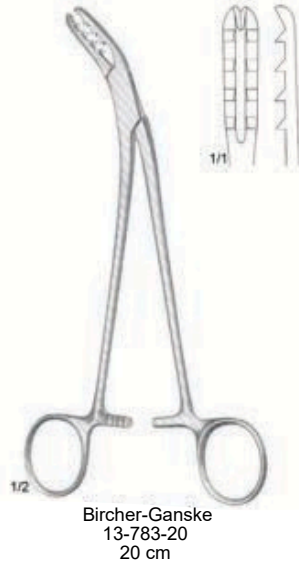
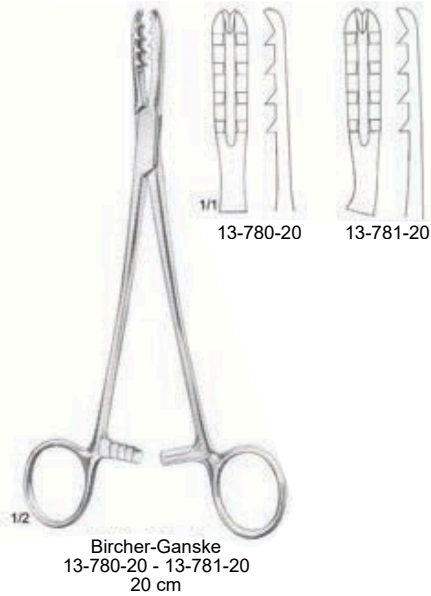

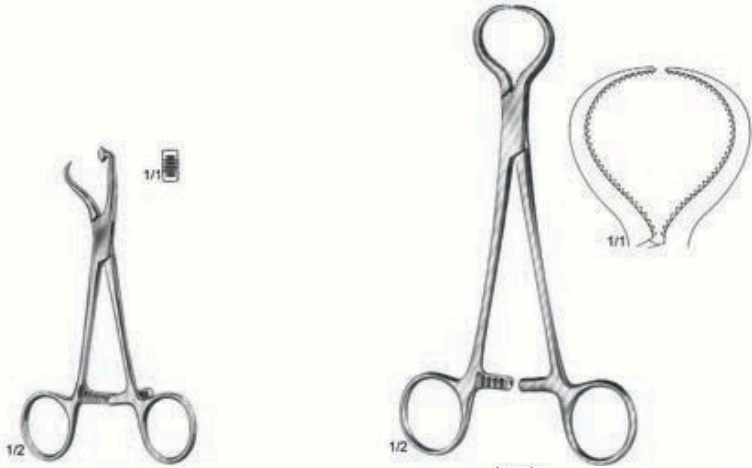

13-791-12  
12 cm

Lewin  
13-792-17  
17.5 cm

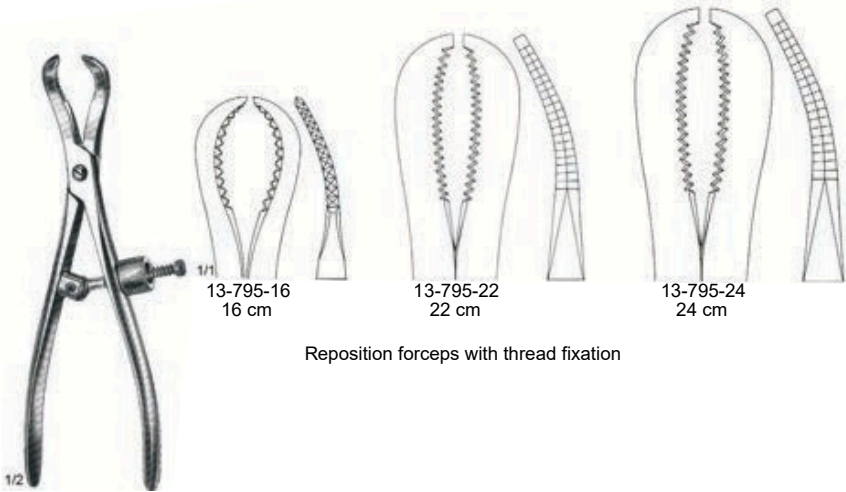

13-795-16  
16 cm

13-795-22  
22 cm

13-795-24  
24 cm

Reposition forceps with thread fixation

13-795-16 - 13-795-24

Bone Surgery - Knochenchirurgie - Cirugía ósea  
 Bone Holding Forceps  
 Knochenhaltezaugen  
 Pinzas para huesos



13-800-14  
14 cm



13-801-13  
13.5 cm

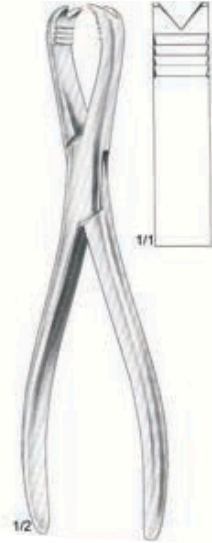

Langenbeck  
13-802-21  
21 cm

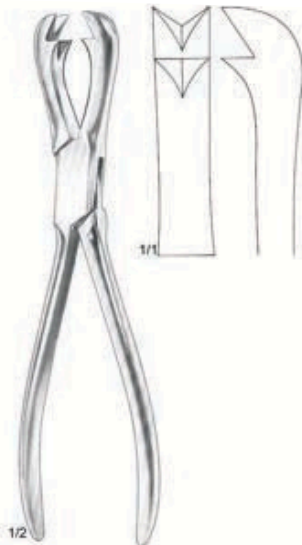

Fergusson  
13-804-21  
21 cm



Frosch  
13-806-18  
18 cm



13-808-20  
20 cm

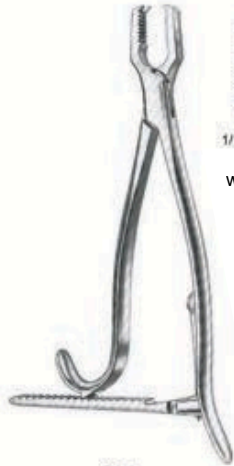

13-810-15  
without ratchet

13-812-15  
with ratchet



13-810-21  
without ratchet

13-812-21  
with ratchet

	Kern	
13-810-15	15 cm	13-812-15
13-810-17	17 cm	13-812-17
13-810-21	21 cm	13-812-21



Semb  
13-813-19  
19 cm



Semb  
13-815-19  
19 cm





13-817-21  
21 cm



13-817-26  
26 cm



13-817-33  
33 cm



Lambotte  
13-817-21 - 13-817-33



Lambotte  
13-819-19 19 cm  
13-819-23 23 cm  
13-819-26 26 cm

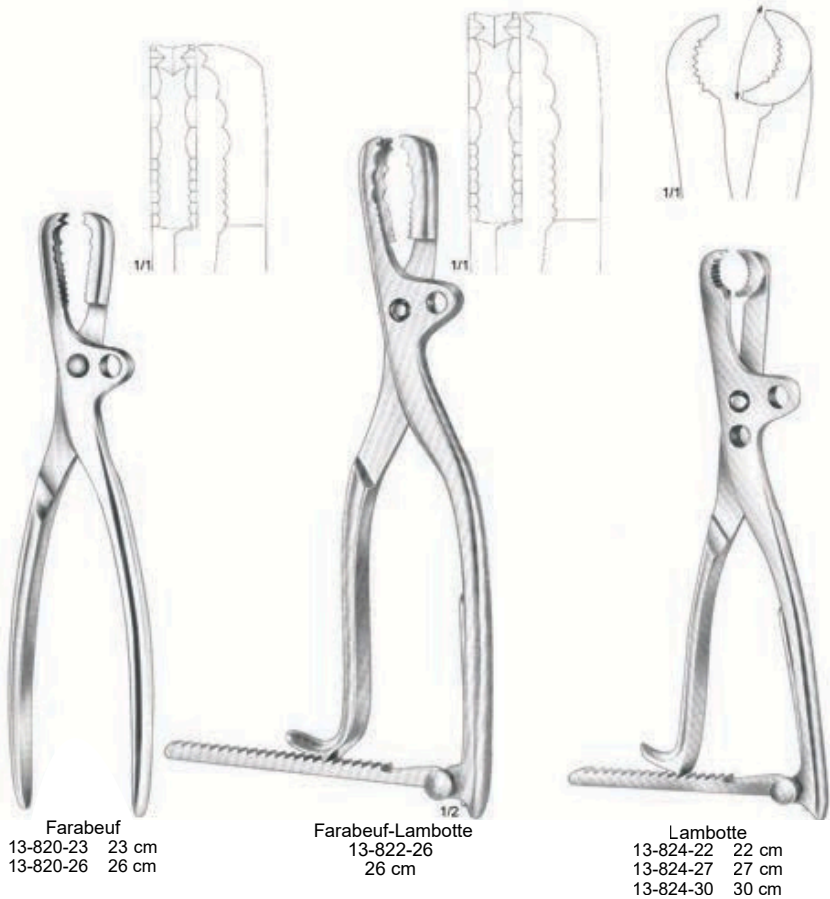

Bone Surgery - Knochenchirurgie - Cirugía ósea  
 Bone Holding Forceps  
 Knochenhaltezaugen  
 Pinzas para huesos



1/1



13-826-23  
 13-827-23  
 23 cm



1/1

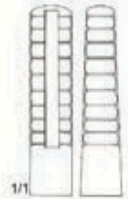

1/1



13-826-25  
 13-827-25  
 25 cm



1/1

13-826-28  
 13-827-28  
 28 cm



Ulrich  
 13-826-23 - 13-826-28



Ulrich  
 13-827-23 - 13-827-28

Bone Surgery - Knochenchirurgie - Cirugía ósea  
Bone Holding Forceps  
Knochenhaltezaugen  
Pinzas para huesos

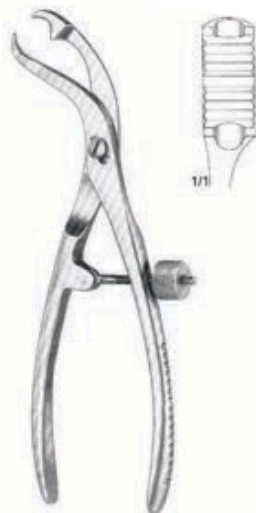
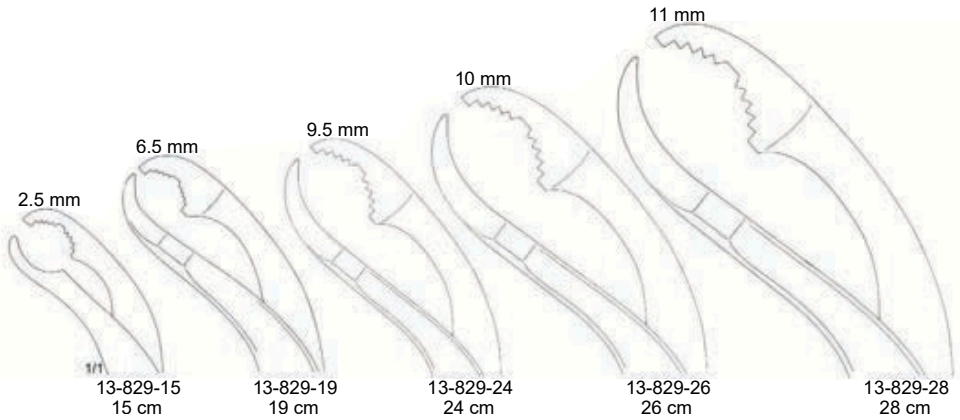

13-829-15 - 13-829-28  
Self-centering forceps with thread fixation

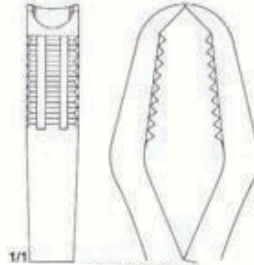

13-830-33  
without ratchet

13-832-33  
with ratchet

13-830-45  
without ratchet

13-832-45  
with ratchet

	Lane	
13-830-33	33 cm	13-832-33
13-830-45	45 cm	13-832-45



Hey Groves  
13-834-21  
21 cm

Hey Groves  
13-834-27  
27 cm

Hey Groves  
13-834-30  
30.5 cm

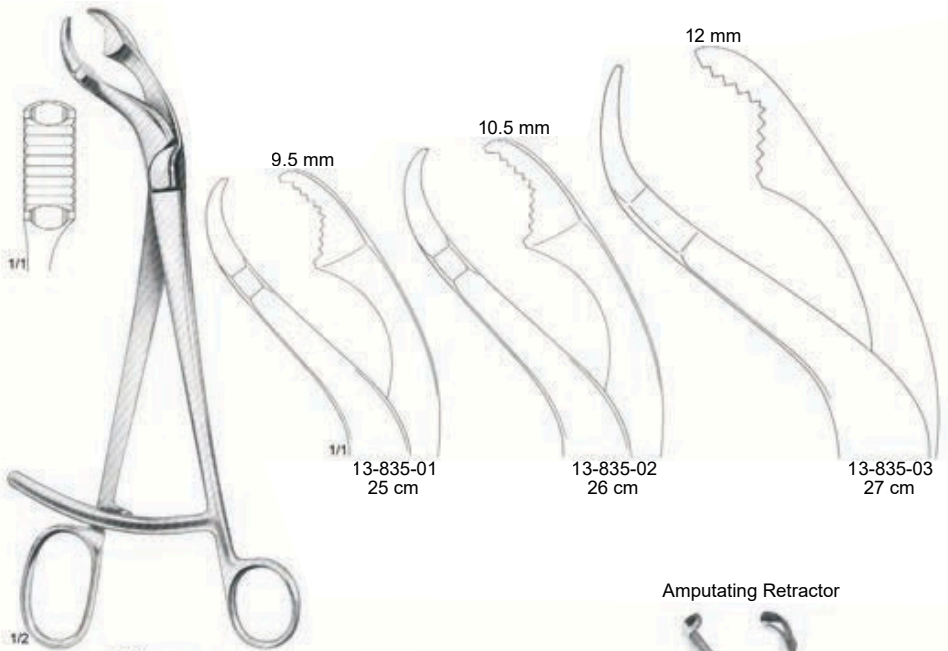

Verbrugge  
 13-835-01 - 13-835-03

Amputating Retractor

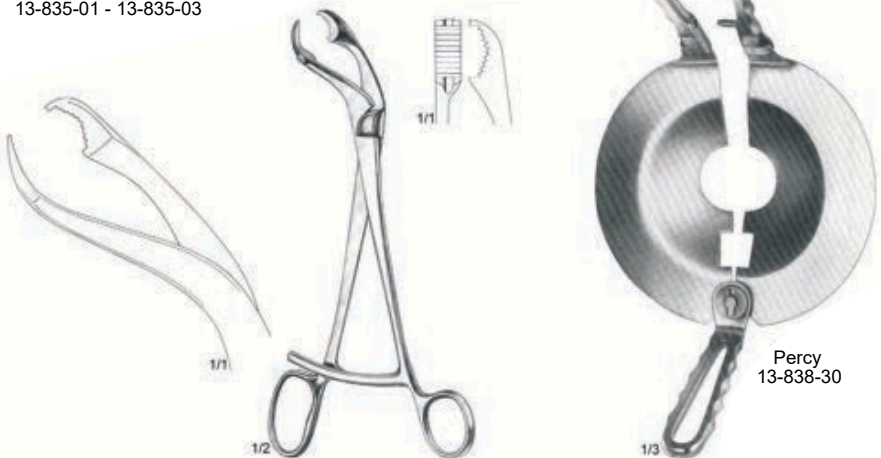

Percy  
 13-838-30

Verbrugge  
 13-837-17  
 17.5 cm



13-839-01  
19 cm

13-839-02  
24.5 cm



13-839-03  
25 cm

13-839-04  
40 cm



13-839-05  
41 cm

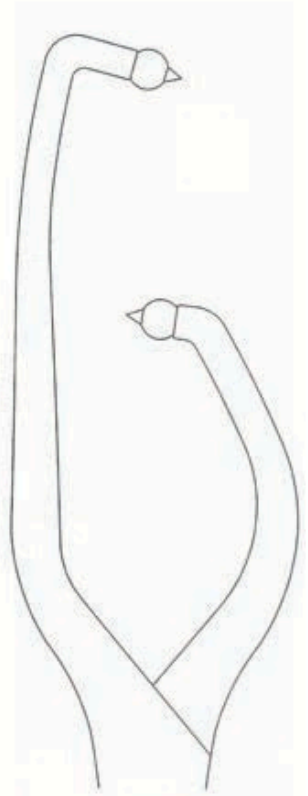

13-839-06  
40.5 cm

13-839-05 - 13-829-06



13-839-07  
34.5 cm

Ball Spike  
13-839-08  
30.5 cm

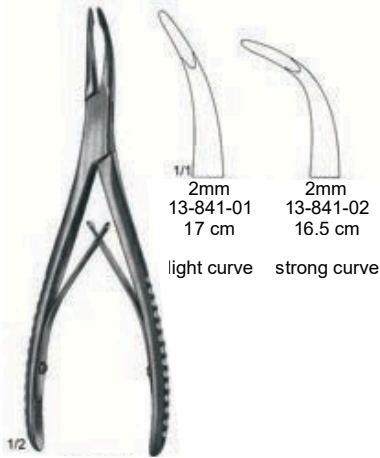

Stellbrink  
 13-841-01 - 13-841-02



Mini-Friedman  
 13-843-12  
 12 cm



Friedman  
 13-845-14  
 14 cm

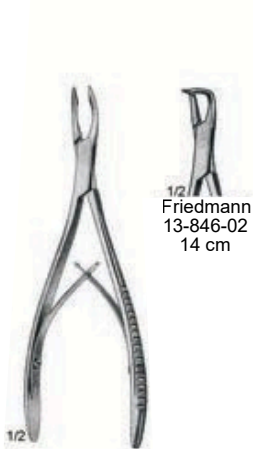

Friedmann  
 13-846-01  
 15 cm

Friedmann  
 13-846-02  
 14 cm

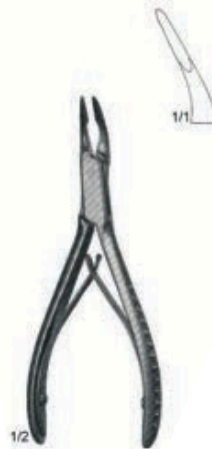

Friedmann-Vickers  
 13-847-14  
 14 cm



Cohen  
 13-849-14  
 14 cm



Hakansson  
 13-850-17  
 17 cm



Cleveland  
 13-851-14  
 14 cm

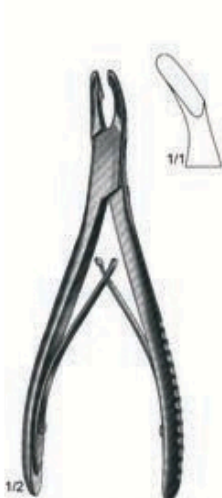

Cleveland  
 13-853-17  
 17 cm

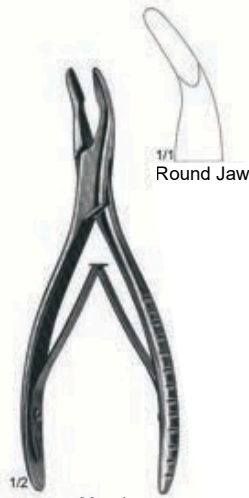

Mead  
 13-855-16  
 16.5 cm

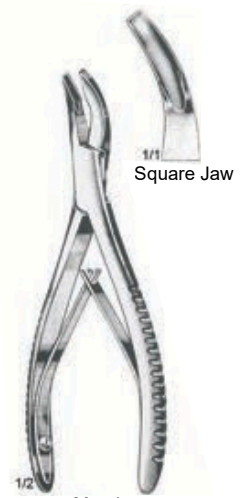

Mead  
 13-856-16  
 16.5 cm



Beyer  
 13-857-18  
 18 cm

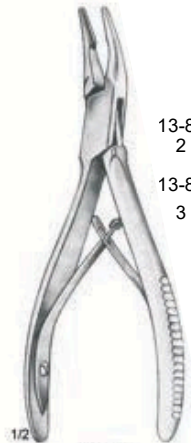

13-858-02  
 2 mm  
 13-858-03  
 3 mm  
 Beyer  
 13-858-02 - 13-858-03  
 17 cm

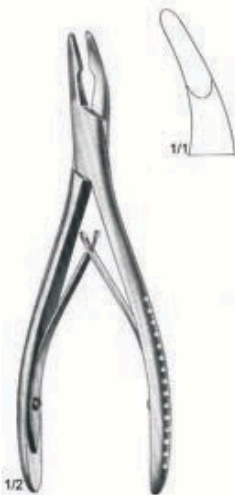

Hartmann  
 13-859-18  
 18.5 cm



Jansen  
 13-860-18 - 13-863-18  
 18 cm

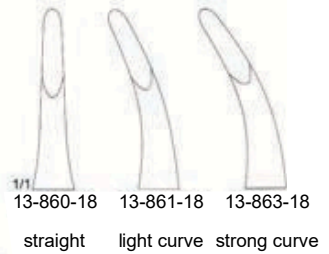

Bone Surgery - Knochenchirurgie - Cirugía ósea  
 Bone Rongeur/Forceps  
 Hohlmeißelzangen  
 Pinzas-gubias

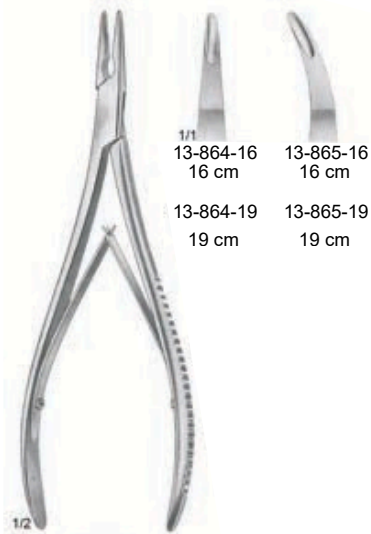

**Lampert**  
 13-864-16 - 13-865-19

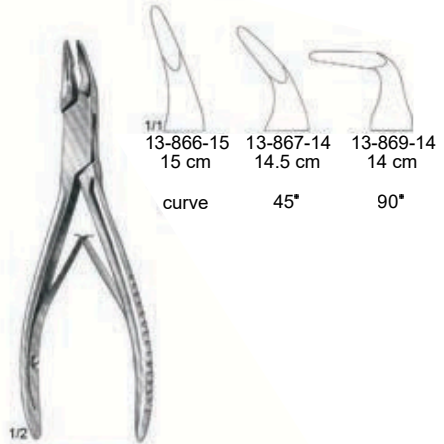

**Blumenthal**  
 13-866-15 - 13-869-14

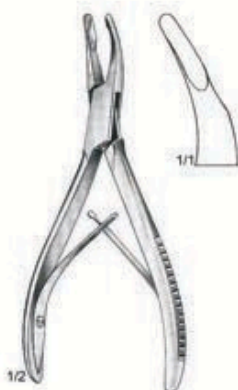

**Universal**  
 13-870-13  
 13.5 cm



**Olivecrona**  
 13-871-20  
 20 cm

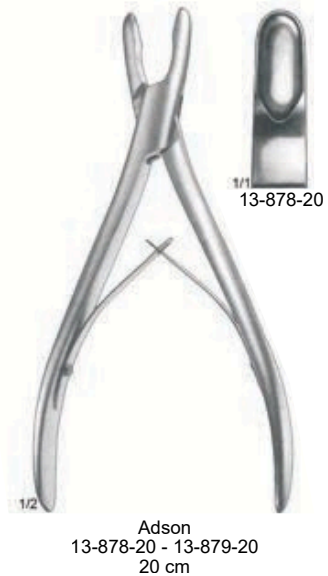
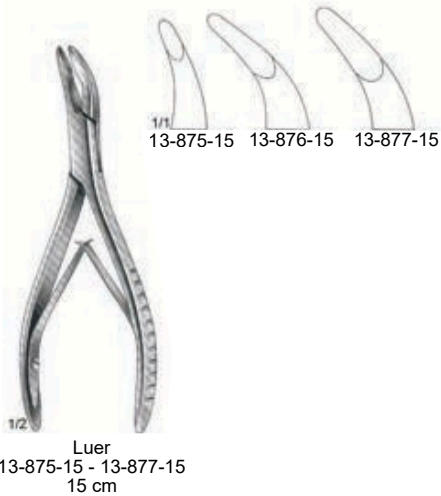
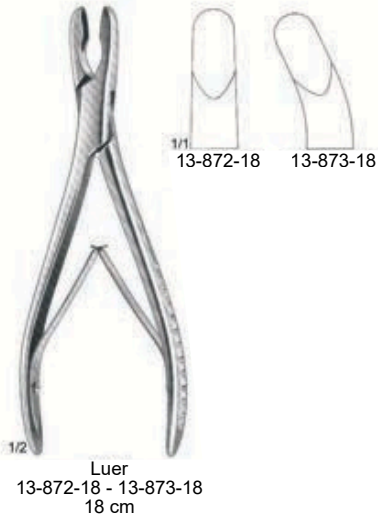

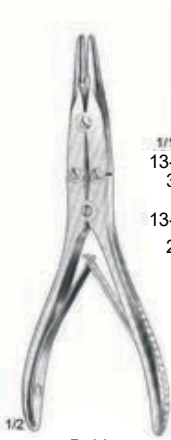

Bohler  
 13-880-02 - 13-881-15  
 15 cm



13-880-15  
 3 mm



13-881-15  
 3 mm

13-880-02  
 2 mm

13-881-02  
 2 mm



Beyer  
 13-889-18  
 18 cm



1/1



Zaufal-Jansen  
 13-885-18  
 18 cm



1/1



Mayfield  
 13-887-17  
 17 cm



1/1



Marquardt  
 13-889-20  
 20 cm



1/1



Ruskin  
 13-890-18 - 13-891-18  
 19 cm



1/1



1/1



Ruskin  
 13-890-23 - 13-891-23  
 23 cm



1/1



1/1

13-890-23

13-891-23



Bane  
 13-892-01  
 18 cm

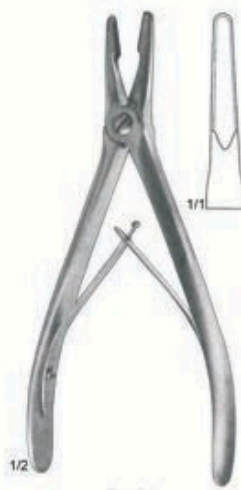

Zaufal  
 13-892-02  
 18 cm



Cottle-Jansen  
 13-892-03  
 18 cm



Jansen  
 13-892-04  
 19 cm



Guleke  
 13-892-05  
 20.5 cm

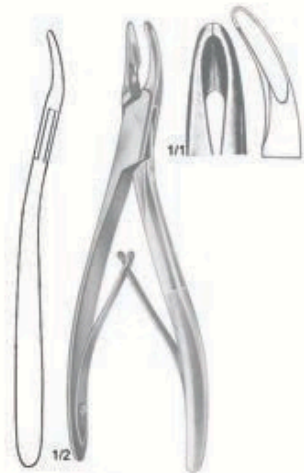

Schell  
 13-892-06  
 17 cm

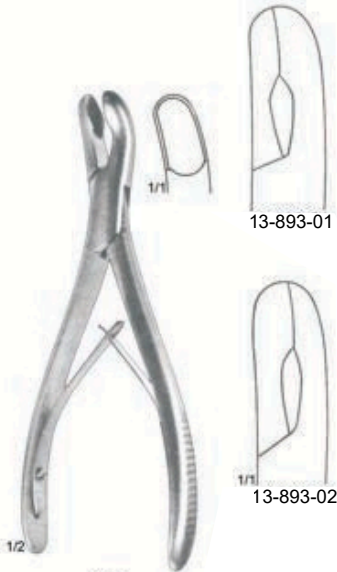

**Fisch**  
 13-893-01 - 13-893-02  
 17 cm



**Bacon**  
 13-894-20  
 20 cm

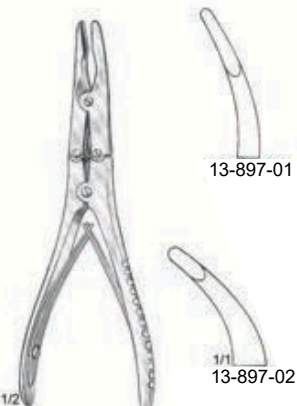

**Kleinert-Kutz**  
 13-897-01 - 13-897-02  
 15 cm

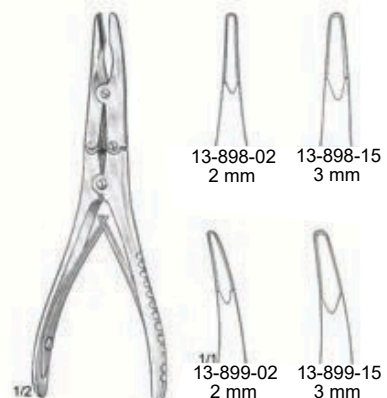

**Ruskin-Mini**  
 13-898-02 - 13-899-15  
 15 cm

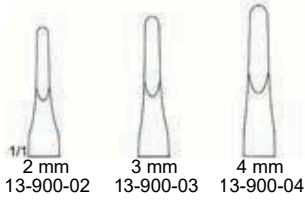

Echlin  
 13-900-02 - 13-900-04  
 23 cm

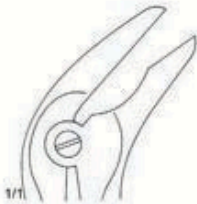

Smith Petersen  
 13-902-01 - 13-902-03  
 24 cm



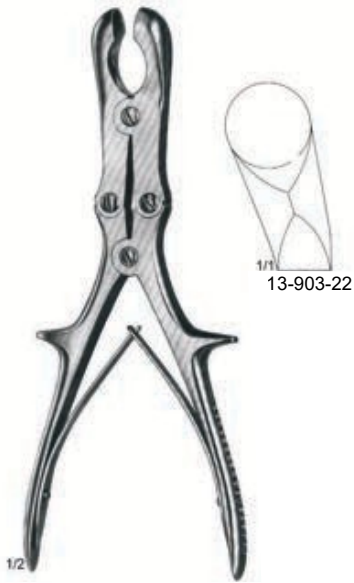

Semb  
 13-903-22 22.5 cm  
 13-903-27 27.0 cm



Stille  
 13-904-23  
 23 cm

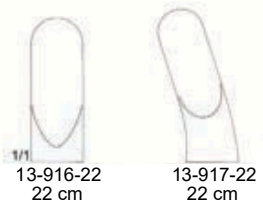
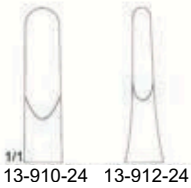

13-916-26 26 cm 13-917-26 26 cm



Leksell-Stille  
 13-910-24 - 13-912-24  
 24 cm



Frykholm  
 13-914-24  
 24 cm



Stille-Luer  
 13-916-22 - 13-917-26



Roettgen-Ruskin  
13-921-24  
24 cm



Stille-Ruskin  
13-923-23  
23 cm



1/1  
 13-926-23 13-926-27



13-927-23 13-927-27



1/1  
 13-930-30



13-932-30



Stille-Luer  
 13-926-23 - 13-927-27

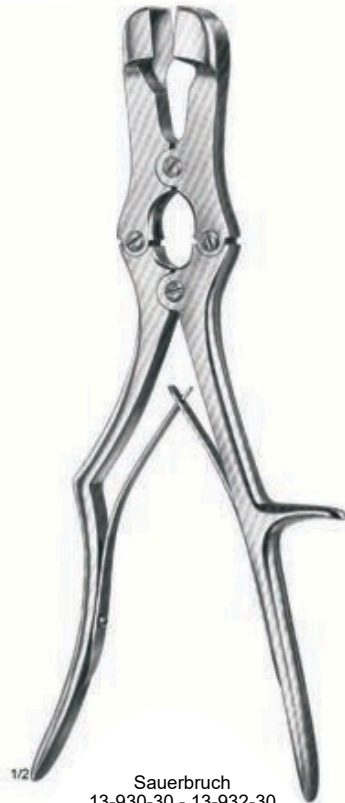

1/2  
 Sauerbruch  
 13-930-30 - 13-932-30  
 30 cm

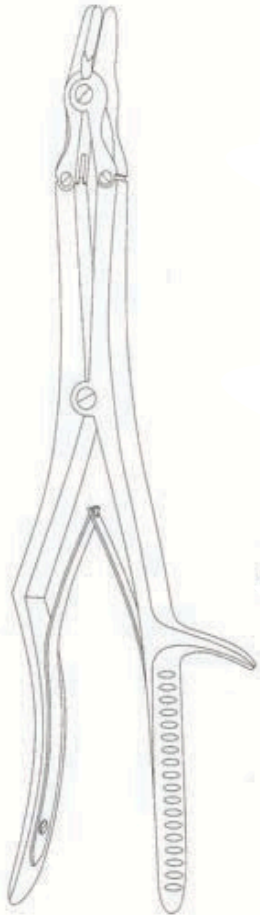

Syfert  
 13-936-03 - 13-936-08  
 35 cm



13-936-03  
 3 mm



13-936-05  
 5 mm



13-936-08  
 8 mm



Dale  
 13-937-03 - 13-937-08  
 35 cm



13-937-03  
 3 mm



13-937-08  
 8 mm

Bone Surgery - Knochenchirurgie - Cirugía ósea  
 Bone Cutting Forceps  
 Knochensplitterzangen  
 Pinzas cortantes para huesos

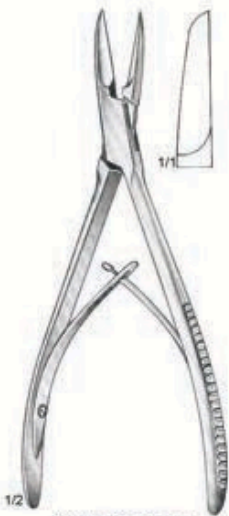

Cottle Kazanjian  
 13-940-19  
 19 cm

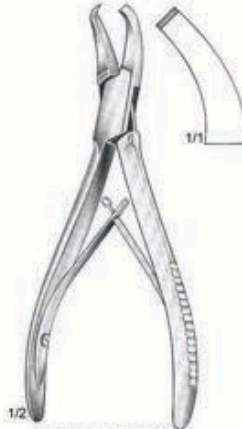

Cleveland-Gardner  
 13-941-16  
 16 cm

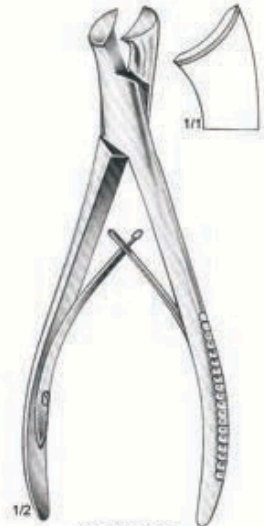

Markwalder  
 13-943-20  
 20 cm

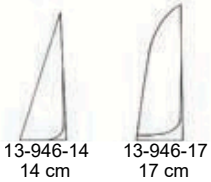

13-946-14 14 cm  
 13-946-17 17 cm

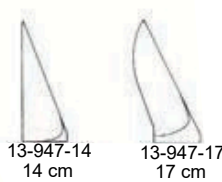

13-947-14 14 cm  
 13-947-17 17 cm

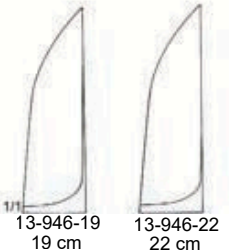

13-946-19 19 cm  
 13-946-22 22 cm

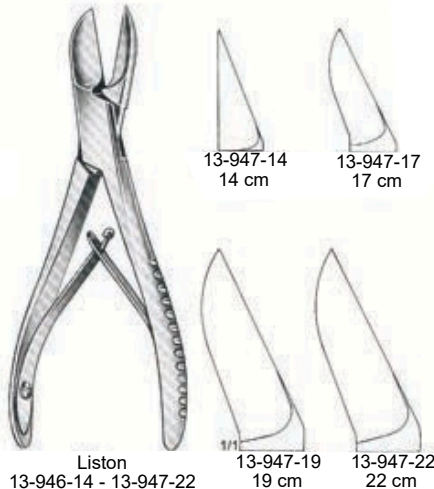

Liston  
 13-946-14 - 13-947-22  
 13-947-19 19 cm  
 13-947-22 22 cm



Littauer-Liston  
 13-948-15  
 15 cm

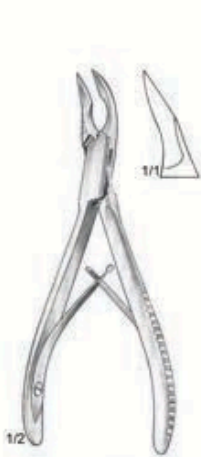

Cleveland  
 13-951-15  
 15 cm

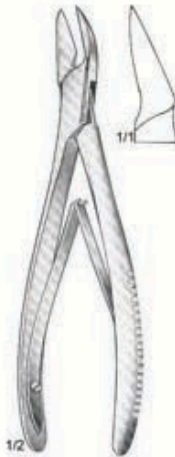

Cleveland  
 13-951-17  
 17 cm



Kleinert-Kutz  
 13-952-15 - 13-953-15  
 15 cm



Ruskin-Liston  
 13-954-18 - 13-955-18  
 18 cm



13-954-18



13-955-18



McIndoe  
 13-957-17  
 17.5 cm



Bohler  
 13-960-15  
 15 cm



Bohler  
 13-961-15  
 15 cm

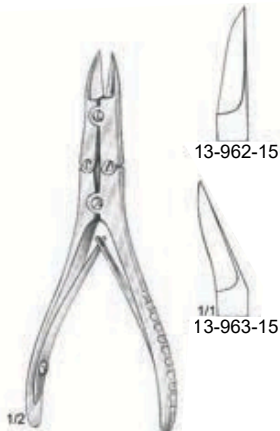

Walton-Liston  
 13-962-15 - 13-963-15  
 15 cm



Bohler  
 13-965-12  
 12 cm

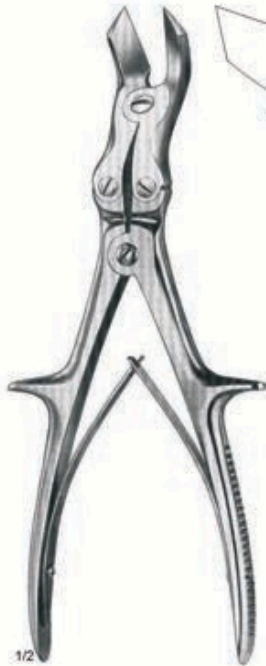

Liston-Key  
13-972-27  
27 cm

(Stille-Horsley)



Semb  
13-973-24  
24 cm

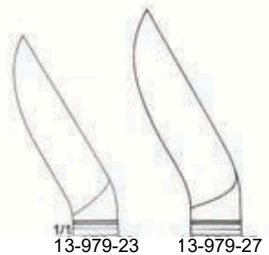
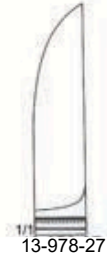
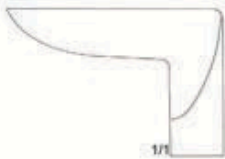

Stille-Liston  
 13-976-27  
 27 cm



Stille-Liston  
 13-978-23  
 23 cm  
 13-978-27  
 27 cm



Stille-Liston  
 13-978-23  
 23 cm  
 13-978-27  
 27 cm



13-981-01  
only saw

1/2  
Mod. Martin  
13-980-17  
17 cm



13-983-01  
only saw

1/2  
Walton  
13-982-16  
16 cm



13-985-01  
only saw

1/2  
13-984-17  
17 cm

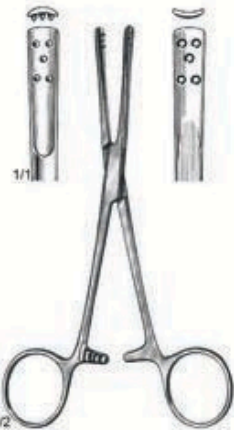

1/1  
1/2  
Penner  
13-986-15  
15.5 cm

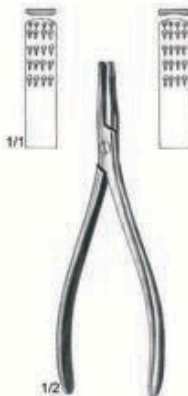

1/1  
1/2  
Radolf  
13-988-13  
13.5 cm



1/1  
1/2  
13-989-14  
14.5 cm

Bone Surgery - Knochenchirurgie - Cirugía ósea  
 Wire Instruments  
 Drahtinstrumente  
 Instrumentos para alambre

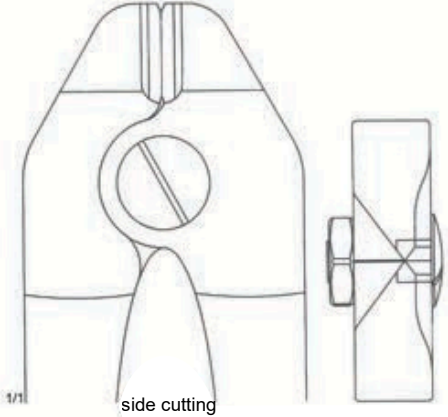
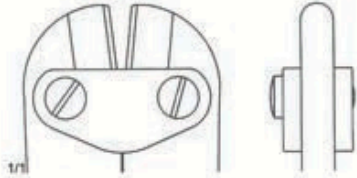

for wires upto  
 $\varnothing$  3.2 mm

for wires upto  
 $\varnothing$  4.0 mm



Pin Cutter Double Action  
 13-990-23  
 23 cm

Side Pin Cutter - TC  
 13-992-37  
 37.5 cm

end cutting

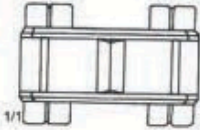
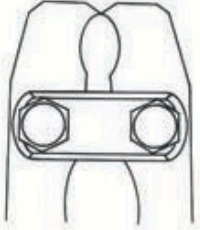

for wires upto  
 $\varnothing$  3.2 mm



Pin Cutter (Small)  
 13-994-25  
 25 cm

for wires upto  
 $\varnothing$  4.7 mm



Pin Cutter (Medium)  
 13-996-40  
 40 cm

end cutting

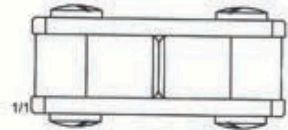
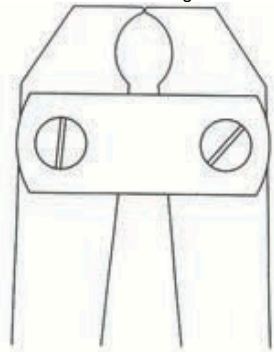

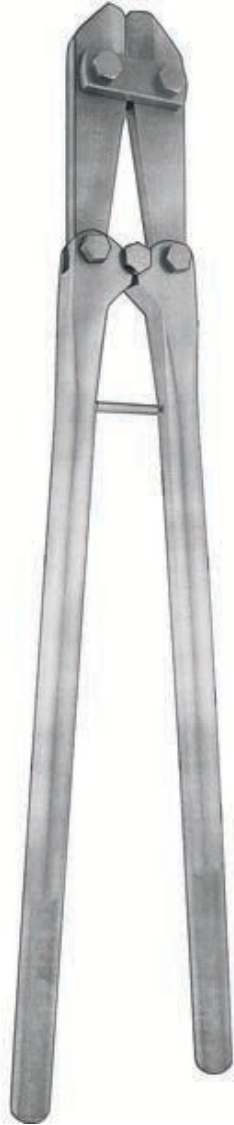

Pin Cutter (Large)  
13-998-46 46 cm  
13-998-54 54 cm

for wires upto  
Ø 6.0 mm



		for wires upto
13-999-38	38 cm	Ø 5.0 mm
13-999-45	45 cm	Ø 6.0 mm
13-999-56	56 cm	Ø 7.5 mm

Pin Cutter  
13-999-38 - 13-999-56



T Handle  
33-100-00



Handle For AO Attachment  
33-110-00



Dental Handle  
33-120-00



33-130-15  
1.5 mm



33-130-25  
2.5 mm



33-130-35  
3.5 mm



AO	Ø mm	mm
33-150-11	1.	60 / 35
33-150-15	1	85 / 60
33-150-20	1.	100 / 75
33-150-25	5	110 / 85
33-150-27	2.	100 / 75
33-150-32	0	145 /
33-150-35	2.	120
33-150-45	5	110 / 85
33-150-60	2.	145 /
	7	120
	3.	195 /
	2	170
	3.	
	5	
	4.	
	5	
	6.	
	6	



AO	Ø mm
33-156-	1.
15 33-	5
156-20	2.
33-156-	0
27	2.
33-156-	7
35	3.
33-156-	5
45 33-	4.
156-65	5
	5



Kuentscher  
 33-180-08 8 mm  
 33-180-10 10 mm  
 33-180-12 12 mm  
 26 cm



Kuentscher  
 33-186-63  
 63 cm



Kuentscher  
 33-186-01  
 Fig 1



Kuentscher  
 33-186-02  
 Fig 2

33-188-00 (33-186-01 + 33-186-02 + 33-186-63)



Extraction Hook  
33-200-29 29  
33-200-37 cm  
33-200-42 37  
33-200-49 cm  
42  
cm  
49  
cm



Slotted Hammer  
33-210-30  
30 cm



Lloyd Impactor  
33-220-20  
20 cm



Philips Head  
33-300-01



Slotted Head  
33-300-02



Single Head  
33-300-03



Hexagonal Head  
33-300-04



Williams  
33-800-01 - 33-300-04  
24 cm



Holding Forcep For Small Plates  
 33-360-12  
 12 cm



Screw Holding Forcep  
 33-374-08  
 8 cm



Bending Iron For Small Plates  
 33-390-13 33-394-01 33-394-02  
 13 cm 14.5 cm 14.5 cm



Bending Iron For Large Plates  
 33-400-24 Solid  
 33-402-24 Light Weight  
 24 cm



Bending Plier  
 33-410-14  
 14 cm



Bending Plier  
 33-414-14  
 14 cm

1.5 / 2 mm Plate



Bending Press  
 33-440-00



Tap & Drill Sleeve  
 33-500-00  
 2.7 / 1 mm



Tap  
 33-520-35 Ø 3.5 mm  
 33-520-45 Ø 4.5 mm  
 33-520-70 Ø 7.0 mm



Hexagonal Key  
 33-530-40 4.0 mm  
 33-530-45 4.5 mm  
 33-530-70 7.0 mm



Hexagonal Screw Driver  
 33-540-25 2.5 mm  
 33-540-35 3.5 mm



33-550-50  
 5 mm



Parallel Aiming Device For Guide  $\varnothing$  2 mm  
 33-600-02



Tissue Protector Sleeve For Cannulated Screws  $\varnothing$  7 mm  
 33-610-07

1.1 mm



Counter Sink  
 33-620-11

For Mini Screws  
 1.5 / 2 mm

2 mm



Counter Sink  
 33-620-20

For Small Screws  
 2.7 / 3.5 / 4 mm

3.2 mm



Counter Sink  
 33-620-32

For Malleolar Screws  
 4.5 mm

4.5 mm



Counter Sink With T-Handle  
 33-624-45

For Large Screws  
 4.5 / 6.5 mm



**Insert Drill Sleeve**  
 33-650-27 2.7 / 2.0  
 33-650-35 mm 3.5 /  
 33-650-45 2.5 mm 4.5  
 / 3.2 mm



**Mini Drill Sleeve**  
 33-660-11 1.1 / 1.5  
 33-660-15 mm 1.5 /  
 2.0 mm



**Triple Drill Guide & Sleeve**  
 33-666-20  
 2 mm

Sharp



**Hooklet**  
 33-680-15  
 15.5 cm



33-700-00

Mini



33-704-00

Small



33-708-00

Large



Pointed Drill Guide  
33-740-45



Drill Guide With Two Inserts  
33-744-45



Tap Sleeve 3.5 mm For Tap 2.7 mm  
33-748-35



Tap & Drill Sleeve  
33-752-27 2.7 / 2.0 mm  
33-752-35 3.5 / 2.5 mm



Tap Sleeve For Large Cannulated Screws  
33-756-45  
4.5 mm



Drill Sleeve For Tension Device  
 33-760-32  
 Ø 3.2 mm



Drill Guide For Round Hole Plates For Drill Bits  
 33-764-40      33-764-60  
 Ø 3.2 mm      Ø 3.2 mm

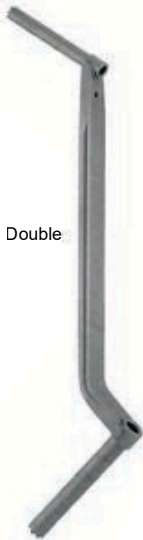

Double

33-780-45  
 4.5 / 3.2 mm



Double

33-784-32  
 3.2 / 6.5 mm



Universal

33-790-25  
 2.5 mm



Universal

33-794-32  
 3.2 / 4.5 mm



Hub  
33-800-22  
20 mm



Ø 4.5 mm

Pin Wrench  
33-804-12  
12 cm



Spanner  
33-810-11  
11 mm



33-816-11  
11 mm



Neutral Drill Guides  
 33-840-20 2.0 mm  
 33-840-27 2.7 mm  
 33-840-35 3.5 mm  
 33-840-45 4.5 mm



Neutral Drill Guides  
 33-846-60  
 4.5 mm



Wire Tightner  
 33-870-01



Wire Tightner  
 33-870-02



Bending Iron For Wire Drills  
 33-880-00

Ø 6 mm



Plat Tip Bit  
33-900-01

Ø 6 mm



Cross Tip Bit  
33-900-02

Ø 5 mm



Philips Large  
33-900-03

Ø 4 mm



Philips Small  
33-900-04

Ø 3.5 mm



Hexagonal Large  
33-900-05

Ø 2.5 mm



Hexagonal Small  
33-900-06



Screw Driver With Bore & Quick Action Chuck  
33-900-10

33-906-00 (33-900-01 - 33-900-10)  
Complete

Ø 2.5 mm



Threaded Guide Pin  
 33-950-01  
 23 cm

Adjustable  
 135°/140°/145°/150°



Aiming Device  
 33-950-02



Guide Wire  
 33-950-03



Triple Combo Reamer  
 33-950-04



Tap  
 33-950-05



Guide Sleeve  
 33-950-06

Long



Guide Sleeve  
 33-950-07



Guide Shaft  
33-950-08



Guide Shaft  
33-950-09



Coupling Screw  
33-950-10

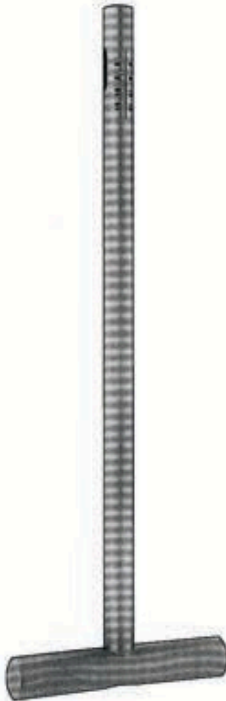

Wrench  
33-950-11



Impactor  
33-950-12

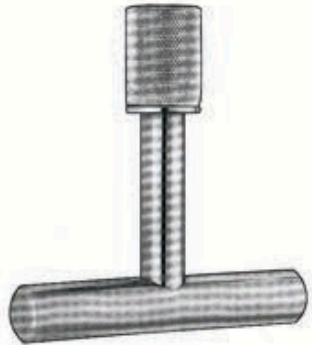

T-Handle  
33-950-13



Plate Bending Plier  
33-970-16  
16 cm

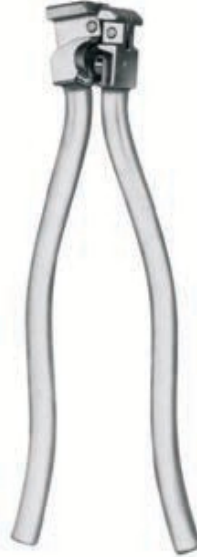

Plate Bending Plier  
33-972-25  
25.5 cm

# Index

<b>A</b>			
Adson Bone Rongeur	13-113	Cleveland Bone Cutting Forcep	13-124
Adson Drill Guide and Dura Protecting Forcep	13-3	Cleveland Bone Rongeur	13-110
Adson Elevator	13-77	Cleveland-Gardner Bone Cutting Forcep	13-123
Aiming Device For DHS	33-16	Clips	13-29
Alderdyce Elevator	13-79	Cloward Hibbs Spratt Spinal Fusion Bone Curette	13-60
Alexander Bone Chisel	13-32	Cobb Bone Curette	13-63
Alexander Bone Gouge	13-32	Cobb Bone Gouge	13-37
Alexander Periosteal Raspatory	13-74	Cobb Elevator	13-78
Amputating and Resection Saws	13-2	Cobb Periosteal Raspatory	13-70
Arthroscopy Instrument	13-4—13-9	Cohen Bone Rongeur	13-110
		Collin Hammer	13-47
		Compression Devices	33-13
<b>B</b>		Corwin-Hegar Wire Twisting Forcep	13-17
Bacon Bone Rongeur	13-116	Cottle Hammer	13-49
Ball Spike	13-108	Cottle Kazanjian Bone Cutting Forcep	13-123
Bane Bone Rongeur	13-115	Cottle-Jansen Bone Rongeur	13-115
Barth Bone Curette	13-66	Counter Sinks	33-9
Baumgartner Wire Twisting Forcep	13-18	Coupling Screw For DHS	33-17
Bending Iron For Large Plates	33-7	Cushing Burr for Hudson Hand Drill	13-12
Bending Iron For Small Plates	33-7		
Bending Iron For Wire Drills	33-14	<b>D</b>	
Bending Plier	33-7	Dale Bone Rongeur	13-122
Bending Press	33-8	Daubenspeck Bone Curette	13-61
Bennett Bone Lever	13-83	Defoulement Bone Rongeur	13-113
Bergmann Hammer	13-45	Demel Bone Wire Guide	13-27
Beyer Bone Rongeur	13-111, 13-114	Demel Bone Wire Tightener	13-28
		Dental Handle	33-2
Bircher Menisectomy Knife	13-88	Depth Gauges	33-10
Bircher-Ganske Meniscus and Cartilage Forcep	13-94	DHS Instruments	33-16—33-17
Blount Bone Lever	13-87	Dingmann Meniscus and Cartilage Forcep	13-94
Blumenthal Bone Rongeur	13-112	Dingmann-Modif Meniscus and Cartilage Forcep	13-94
Bohler Bone Cutting Forcep	13-125	Double & Universal Drill Guides	33-12
Bohler Bone Rongeur	13-114	Doyen Hammer	13-46
Bohler Extension Bow	13-29	Doyen Periosteal Raspatory	13-72
Bone Chisels	13-31—13-33 13-38, 13-40	Drill Bits	33-2
Bone Currettes	13-56—13-66	Drill Guide	33-11, 33-12, 33-14
Bone Cutting Forceps	13-123—13-127	Drill Holders	33-2
		Dynamic Hip Screw Instruments	33-16—33-17
Bone Drills	13-3		
Bone Files	13-75	<b>E</b>	
Bone Gouges	13-31—13-35 13-37—13-40	Echlin Bone Rongeur	13-117
Bone Holding Clamps	13-10—13-11	Elevators	13-77—13-79
Bone Holding Forceps	13-95—13-104	Extension Bows	13-29—13-30
		Extraction Hook	33-4
Bone Levers	13-80—13-87		
Bone Nailing Instruments	33-3, 33-4	<b>F</b>	
Bone Osteotomes	13-31, 13-33 13-35—13-36 13-39—13-43	Farabeuf Bone Holding Forcep	13-99
		Farabeuf Periosteal Raspatory	13-68
Bone Rasps	13-43	Farabeuf-Collin Periosteal Raspatory	13-69
Bone Retractor	13-104	Farabeuf-Lambotte Bone Holding Forcep	13-99
Bone Rongeurs	13-109—13-122	Feldheim Nail Instrument	13-44
		Fergusson Bone Holding Forcep	13-96
Bone Wire Guides	13-27—13-28	Finger Ring Saws	13-128
Bone Wire Tighteners	13-27—13-28	Fisch Bone Rongeur	13-116
Brand Tendon Seizing Instrument	13-91	Fischer Tendon Tunnel Instrument	13-90
Bruns Bone Curette	13-58—13-59	Flat Nose Pliers	13-19—13-22
Buck-Gramcko Bone Lever	13-80	Friedman Bone Rongeur	13-109
Bunnel Hand Drill	13-13	Friedman-Vickers Bone Rongeur	13-109
Bunnel Tendon Stripper	13-89	Frosch Bone Holding Forcep	13-96
Bunnel Tendon Tunnel Instrument	13-90	Frykholm Bone Rongeur	13-119
Bunnell-Howard Bone Holding Clamp	13-11		
Burs	13-12, 13-14	<b>G</b>	
		Gardner Hammer	13-55
<b>C</b>		Gerster Bone Holding Clamp	13-11
Caroll Tendon Seizing Instrument	13-91	Gerster-Lowman Bone Holding Clamp	13-10
Chandler Bone Lever	13-85	Gerzog Hammer	13-55
Charriere Amputating and Resection Saw	13-2	Gouges	13-38
		Guide Shaft For DHS	33-17
		Guide Sleeve For DHS	33-16

# Index

Guide Wire ForDHS	33-16		
Guleke Bone Rongeur	13-115		
<b>H</b>			
H Hackstock Flat Nose Pliers			
Hajek Hammer Hakansson Bone Rongeur	13-22		
Halle Bone Curette	13-50		
Hammers Hand Drills Handle For AO Attachment Hartmann Bone Rongeur	13-110		
Harvey Wire Cutting	13-64		
Harvey Wire Cutting	13-34—13-43		
Hatfield Bone Curette	13-12—13-15		
Herz	33-2		
Hemingway Bone Curette	13-111		
Henderson Seizing Instrument	13-111		
Hexagonal Key Hexagonal Screw Driver	13-23		
Hey Groves Bone Holding Forcep	13-63		
Hibbs Bone Chisel Hibbs Bone Gouge	13-66		
Hibbs Bone Gouge	13-91		
Hohmann Bone Lever	33-8		
Hohmann-Aldinger Bone Lever	33-8, 33-15		
Hoke Bone Osteotome Holding Forcep	13-103		
For Small Plates Hooklet	13-40		
House Bone Curette Hub Hudson Hand Drill	13-40		
	13-81—13-82		
	13-84		
	13-43		
	33-7		
	33-10		
	13-66		
	33-13		
	13-12		
<b>I</b>			
Ideal Nail Instrument	13-44		
Impactor For DHS	33-17		
Insert Drill Sleeve	33-10		
Instruments For Bone Plates & Screws	33-7, 33-8		
Instruments For Dynamic Hip Screws	33-16—33-17		
<b>J</b>			
Jansen Bone Curette	13-65		
Jansen Bone Rongeur	13-111, 13-115		
<b>K</b>			
Kern Bone Holding Forcep	13-97		
Kirschner Extension Bow	13-30		
Kleinert-Kutz Bone Cutting Forcep	13-124		
Kleinert-Kutz Bone Rongeur	13-116		
Kleinert-Kutz Tendon Seizing Instrument	13-92		
Kuentscher Bone Nailing Instrument	33-3		
<b>L</b>			
Lambert-Lowman Bone Holding Clamp	13-11		
Lambotte Bone Holding Forceps	13-98, 13-99		
Lambotte Bone Osteotome	13-42		
Lambotte Periosteal Raspatory	13-72		
Lampert Bone Rongeur	13-112		
Lane Bone Holding Forcep	13-102		
Lane Bone Lever	13-86		
Lane Screw Driver	33-5		
Lane Trethowan Bone Lever	13-86		
Lange-Hohmann Modif Bone Lever	13-84		
Langenbeck Amputating and Resection Saw	13-2		
Langenbeck Bone Holding Forcep	13-96		
Langenbeck Elevator	13-77—13-78		
Langenbeck Periosteal Raspatory	13-68		
Lead Hands	13-44		
Leksell-Stille Bone Rongeur	13-119		
Lempert Bone Rongeur	13-87		
Lempert Bone Holding Forcep	13-95		
Lexer Bone Gouge	13-34, 13-38		
Lexer Bone Osteotome	13-35—13-36		
<b>L</b>			
Lexer Gouges	13-38		
Liston Bone Cutting	13-13		
Liston-Key Bone Cutting Forcep	13-126		
Littauer-Liston Bone Cutting Forcep	13-123		
Lloyd Impactor Loute Bone Wire Tightner	13-123		
Lowman-Baby Bone Holding Clamp	33-4		
Lowman-Hoglung Bone Holding Clamp	13-27		
Lucae Hammer	13-11		
Lucas Bone Curette	13-11		
Luer Bone Rongeur	13-47		
	13-66		
	13-113		
<b>M</b>			
Mallets	13-45—13-55		
Markwalder Bone Cutting Forcep	13-123		
Marquardt Bone Rongeur	13-114		
Martin Meniscus and Cartilage Forcep	13-94		
Martin Wire Twisting Forcep	13-17		
Martin-Cushing Periosteal Raspatory	13-67		
Martin-Diamant Wire Cutting Plier	13-25		
Martin-Hoen Periosteal Raspatory	13-67		
Martini Bone Curette	13-65		
Martin-Langenbeck Elevator	13-77		
Martin-Langenbeck Periosteal Raspatory	13-67		
Martin-TC Wire Twisting Forcep	13-17		
Matson Periosteal Raspatory	13-74		
Mayfield Bone Rongeur	13-114		
Mc Indoe Bone Cutting Forcep	13-124		
McDonald Elevator	13-79		
Mead Bone Rongeur	13-110		
Mead Hammer	13-51		
Meniscotomy Knives	13-88		
Meniscus and Cartilage Forceps	13-94		
Meyer Reposition Forcep	13-93		
Mini Drill Sleeve	33-10		
Mini-Friedman Bone Rongeur	13-109		
Mini-Hohmann Bone Lever	13-80		
Mini-Lambotte Bone Osteotome	13-41		
Mini-Lexer Bone Gouge	13-35		
Mini-Lexer Bone Osteotome	13-35		
Mod. Martin Finger Ring Saw	13-128		
Mod. USA Bone Curette	13-64		
Murphy-Lane Bone Lever	13-85		
<b>N</b>			
Nail Instruments	13-44, 13-128		
Neff Meniscotomy Knife	13-88		
Neutral Drill Guides	33-14		
<b>O</b>			
Olivecrona Bone Rongeur	13-112		
Ombredanne Hammer	13-45		
Optional Instruments	33-18		
Osteosynthesis Instruments	33-9—33-12		
<b>P</b>			
Parallel Aiming Device	33-9		
Parham Bone Wire Guide	13-28		
Parham Bone Wire Tightener	13-28		
Partsch Bone Chisel	13-32		
Partsch Bone Gouge	13-32		
Partsch Hammer	13-51		
Patella Forcep	13-93		
Pelvic Reduction Forceps	13-105—13-108		
Penner Nail Instrument	13-128		
Percy Bone Retractor	13-104		
Periosteal Raspatories	13-67—13-74		
Perthes Reamer	13-3		
Philips Screw Driver	33-5, 33-15		
Pin Cutter	13-132		
Pin Cutter (Large)	13-131		

# Index

Pin Cutter (Medium) Pin	13-130	T	
Cutter (Small) Pin Cutter	13-130	Tampers	13-76
Double Action Pin	13-129	Tap & Drill Sleeve	33-8, 33-11
Wrench Plate Bending	33-13	Tap For DHS	33-16
Plier Pointed Drill Guide	33-18	Tap Holders	33-2
Putti Bone Rasp	33-11	Tap Sleeve	33-11
	13-43	Taps	33-2, 33-8, 33-16
			33-17
		Taylor Bone Lever	13-87
R		Tendon Seizing Instruments	13-91—13-92
Radolf Nail Instrument	13-128	Tendon Stripper	13-89—13-90
Ralk Hand Drill	13-13	Tendon Tunnel Instruments	13-89—13-90
Reamers	13-3	Tension Device	33-12
Reill Reposition Forcep	13-93	T-Handle	33-2, 33-9, 33-17
Reill Wire Cutting Pliers	13-26		33-17
Reposition Bone Holding Forcep	13-95	T-handle For DHS	33-17
Reposition Forceps	13-93	Thiess Hammer	13-50
Roettgen-Ruskin Bone Rongeur	13-120	Threaded Guide Pin For DHS	33-16
Ruskin Bone Rongeur	13-114	Tissue Protector Sleeve	33-9
Ruskin-Liston Bone Cutting Forcep	13-123	Traction Hook	13-30
Ruskin-Mini Bone Rongeur	13-116	Triple Combo Reamer For DHS	33-16
		Triple Drill Guide & Sleeve	33-10
S		U	
Salenius Menisectomy Knife	13-88	Uffendorfer Bone Curette	13-61
Satterlee Amputating and Resection Saw	13-2	Ulrich Bone Holding Forcep	13-100
Sauerbruch Bone Rongeur	13-121	Universal Bone Rongeur	13-112
Schede Bone Curette	13-57	Universal Drill Guide	33-12
Schell Bone Rongeur	13-115	Universal Wire Cutting Plier	13-19
Schneider Periosteal Raspatory	13-69		
Schneider-Sauerbruch Periosteal Raspatory	13-69	V	
Schumacher (Wagner) Bone Lever	13-84	Van Buren Sequestrum Forcep	13-93
Scoville Bone Curette	13-59	Verbrugge Bone Holding Forcep	13-104
Screw Drivers	33-2, 33-5—33-6, 33-8	Verbrugge-Müller Bone Lever	13-86
	33-15	Vickers Elevator	13-79
Screw Drivers With Interchangeable Blades	33-7	Vickers Hammer	13-54
Screw Holding Forcep	33-7	Volkmann Bone Curette	13-56—13-57
Sebileau Elevator	13-78		13-65
Sedillot Periosteal Raspatory	13-68		
Self-Centering Bone Holding Forcep	13-101	W	
Semb Bone Cutting Forcep	13-126	Wagner Bone Levers	13-85
Semb Bone Holding Forcep	13-97	Wagner Periosteal Raspatory	13-70
Semb Bone Rongeur	13-118	Walton Finger Ring Saw	13-128
Semb Periosteal Raspatory	13-73—13-74	Walton-Liston Bone Cutting Forcep	13-125
Sequestrum Forceps	13-93	Williams Screw Driver	33-6
Side Pin Cutter—TC	13-129	Williger Bone Curette	13-59, 13-65
Simon Bone Curette	13-64		13-66
Sleeve For Screw Driver	33-5	Williger Elevator	13-77
Slotted Hammer	33-4	Williger Hammer	13-46—13-47
Smillie Bone Lever	13-85	Williger Periosteal Raspatory	13-72
Smillie Menisectomy Knife	13-88	Wire Cutting Pliers	13-19, 13-26
Smith Petersen Bone Rongeur	13-117		23—13-19
Smith-Petersen Bone Gouge	13-39	Wire Guides	13-129—13-129
Smith-Petersen Bone Osteotome	13-39	Wire Instruments	13-132, 33-14
Socket & Combination Wrenches	33-13	Wire Tightners	13-19, 33-14
Spanner	33-13	Wire Twisting Forcep	13-16—13-18
Spare Blade for Saw	13-2	Wrench	33-13
Spratt Bone Curette	13-58	Wrench For DHS	33-17
Steinbach Hammer	13-49		
Steinmann Pins	13-29	Z	
Steinmann Tendon Seizing Instrument	13-91	Zaufal Bone Rongeur	13-115
Stellbrink Bone Rongeur	13-109	Zaufal-Jansen Bone Rongeur	13-114
Stille Bone Chisel	13-33	Zielke Bone Gouge	13-38
Stille Bone Gouge	13-33		
Stille Bone Osteotome	13-33		
Stille Bone Rongeur	13-118		
Stille Hand Drill	13-14		
Stille-Liston Bone Cutting Forcep	13-127		
Stille-Luer Bone Rongeur	13-119, 13-121		
	13-120		
Stille-Ruskin Bone Rongeur	13-14		
Stille-Sherman Hand Drill	13-122		
Sypert Bonr Rongeur			



## **MEDIWORLD SURGICAL**

**Mohallah Loharan, Tasleem Pura, Road Ugoki, Sialkot, Punjab, 51310, Pakistan**

 **+92 322 9175763**

 **+92 52 3510585**

 **info@mediworldsurgical.com**

 **www.mediworldsurgical.com**